

ZIVA[®]

— THE WAY TO LIVE™ —



COMMERCIAL EUROPE

CONTENTS

INTRODUCTION

About	04
Our Story	06
Our Work	08
ZIVA Training Club	10
Commitment to Sustainability	12
Commercial Intro	14
Global Key Accounts	16

FREE WEIGHTS

ZVO Solid Steel Urethane Dumbbells and Barbells	24
EX Dumbbell and Barbell Racks	26
ZVO Urethane Grip Discs	34
EX Disc Storage Station	37
ZVO Urethane Dumbbells and Barbells	38
ST Dumbbell and Barbell Racks	41
ZVO Grip Discs	49
ST Disc Storage	51
ZVO Urethane Functional Tribell	52
ST 1-10KG Studio Dumbbell Rack	54
EX Benches	56
SL Grip Discs	67
SL Premium Hexagon Virgin Rubber Dumbbells	72
ST2 10-Pair 3-Tier Hexagon Dumbbell Rack	73
XP Urethane Dumbbells and Barbells	78
XP Dumbbell and Barbell Racks	80
XP Plate Tree	85

FUNCTIONAL

EX Functional Training Station	93
EX Functional Stretch Station	94
EX Functional Corner	96
EX Functional Wall Storage	101
ZVO Medicine Balls	102
ZVO Slam Balls	106
ST Multi-Ball Trees	108
ZVO Premium Wall Ball	110
ZVO Premium Power Core Bag	113
ST Accessories Storage Racks	114
Signature Steel Competition Kettlebells by Steve Cotter	118
SL Virgin Rubber Kettlebells	122
ZVO Bumper Discs	128
XP Bumper Discs	134
ZVO Olympic Bars	140
Specialty Olympic Bars	142
Olympic Bar Storage Stand	143
ZXP Hip Thruster	147
Battle Rope	150
SL TYRE X	154
Plyo Boxes	156
XP Power Sled	163
ZVO Anti-Burst Core-Fit Ball	168
ST 10-Set Studio Barbell Set	171
Yoga Mats	170
ZVO Balance Ball	176

RACKS AND RIGS

EX Training Corner	184
EX Training Tower Bridge	185
EX Training Tower	188
EX Training Accessories	191
EX Half Rack With Storage	194
XP Power Rack With Storage	198
XP Freestanding Space Saver Racks	202
XP Double-Sided Free Standing Space Saving Rigs	206
Modular Rigs	212
XP Rig Attachments	218
XP Storage Racks	220
XP2 Corner	224
XP2 Floor-Mounted Functional Racks	228
XP2 Attachments	231

STUDIO

Performance Hexagon RPU Dumbbells	234
Performance Dumbbell Racks	235
Performance Virgin Rubber Dumbbell	240
Neoprene Tribells	246
Performance Neoprene Tribell Set	247
Performance Storage Racks	248
Performance Half Rack	250
Olympic Bars	252
Performance Rubber Bumper Plate	255
Performance Olympic Bar Rack	256
Performance Disc Storage Rack 18 Plates	257
Performance Cable Attachments	258
Performance Power Core Bag	261
Performance Wall Ball	264
Performance Medicine Ball	265
Performance Storage Trees	266
Performance Slam Ball	270
Performance Slam Ball Storage Racks	271
Performance 3-Tier, Ball Storage Rack	273
Performance Power Twist Bag	276
Performance Power Sand Bag	277
Performance Studio Barbell Set	278
Performance Boxing	282
Yoga Mats	284
Performance Core-Fit Ball	288
Performance Kettlebells	289
Performance 3 Tier-Universal Storage Rack	294
Performance Plyo Boxes	295
Performance Battle Rope	299
Performance Bodyweight Trainer System	300
Accessories	302





ZIVA® is an elite-performance sports and wellness brand. Distilled to its essence, our brand is driven by the peace of harmony and the joy of living, expressed most powerfully for us through sport, movement, and strength. This essential drive underpins our efforts to improve the physical and mental health of people all around the world.

This philosophy is reflected in our name. The “ZI” in ZIVA comes from the name of the founder of Daoism, an ancient Eastern religion that emphasizes harmony; living in accord with both the nature around you, and with your own nature; and cultivating an attitude of gratitude and happiness by following what it refers to as “The Way.” The “VA” in ZIVA is the second half of the Spanish word “viva,” which means to live fully, to strive with all your heart, and which is an exclamation proclaiming the absolute joy of life and all that it entails.

Our philosophy is embodied in our products. Their premium, progressive design is made to exist in beautiful, artful harmony with high-class gyms and modern homes while their rugged, high-performance functionality invites movement and energetic exertion.

And our philosophy is lived by every team member every day as we work in harmony with one another, joyously striving to bring holistic fitness to the world.

This is ZIVA and our WAY TO LIVE.



A woman with long blonde hair, wearing a black ZIVA tank top and black leggings, is sitting on the floor in a gym. She is looking off to the side with a thoughtful expression. Next to her is a black kettlebell with the number '12' and the ZIVA logo in gold. The background is a dark, textured wall.

OUR STORY

The ZIVA® Journey began in 2008 in a single, out-of-the-way gym where from our earliest days, we sought to provide athletes and fitness enthusiasts with a transformational platform that could empower their fitness journey.

The things we practiced in the gym forged the values at the core of our company: innovation, inspiration, and precision. Our business has changed radically over the past decade and a half; we still have that out-of-the-way gym, but it's now part of the HQ of a global corporation where we coordinate design, manufacturing, marketing, and shipping of over 1,000 SKUs in over 80 markets.

Though we have grown, we will never outgrow the values we first formed in the gym. Today those values are expressed in our products with innovative solutions, inspirational designs, and precision manufacturing.

OUR WORK

We create commercial products tailor-made for the world's most recognizable gyms as well as gorgeous equipment made especially for at-home training. We are renowned for our outstanding quality, inspiring product design, and the refreshing solutions we deliver. We partner with athletes and associations that stand at the pinnacle of the fitness world. We publish compelling content that excites and energizes while it educates. Our team is powerful, passionate, and positive, and we are driven to innovate, iterate, and improve.



ZIVA TRAINING CLUB

At ZIVA®, our aim isn't just to grow a fitness business, it's to build a fitness legacy that ensures the future vitality of the industry we love so much. That's why we invest so heavily in high quality content, including exciting, engaging instruction for at-home athletes, and elite-level professional education and programs for the fitness pros using our equipment in commercial settings every day to improve the lives of those they train.

The ZIVA Training Club is a constantly growing worldwide collaboration of top-level trainers, innovators, and competitors making training content that uses proven methodologies, science-based programming, and fantastic production values that deeply engage athletes at all levels. Curated by our Director of Education, the content found here features professional ZIVA trainers, brand ambassadors, and presenters who deliver world-class training that turns every viewer into a VIP client.

ZEL ZIVA EXERCISE LIBRARY

This yellow icon identifies home and commercial products featured in the ZIVA Exercise Library. The ZIVA Exercise Library is an online database of exercise demos and tutorials built around ZIVA kit to inspire fresh approaches to exercise while mitigating unnecessary risk of injury.

ZEP ZIVA EXERCISE PROGRAMMING

The gray ZEP icon marks home and commercial products featured in programmed exercise templates built to guide enthusiasts and trainers through sample workouts and routines. ZIVA Exercise Programming content may be presented in printed or video formats.



ZIVA® AND THE COMMITMENT TO SUSTAINABILITY

Since our very inception, the ZIVA vision of wellness has been holistic, compromising not only mental, physical, and spiritual health, but the health of the world around us, as well. We have lived our commitment to sustainability from the first ZIVA showroom – One Wellness – which was designed to be carbon neutral all the way back in 2008. It was the very 1st carbon neutral gym in Asia, and the 2nd in the world. Before many had heard of carbon neutrality, it was a personal point of pride for us and a symbol of our commitment to a better world. We renew that commitment every year, using ever more environmentally friendly materials up and down our supply chain.

Today, 100% of our retail packaging is cardboard made from 100% recycled paper and 100% water-based inks. This makes our packaging completely compostable and biodegradable. Within the next year, we will have phased out all plastic in our packaging, as well, making less waste and a more positive impact.

But there's more to sustainability than just packaging. We're also working to tackle waste and improve efficiency in other ways. We're reconfiguring our manufacturing processes, making them leaner and cleaner. We're installing the infrastructure necessary to achieve total carbon neutrality in our China HQ by 2024, and investing to make our factories and our entire supply chain carbon neutral by 2030.

However, we know that we can't do it alone; to create a greener future, we need the help of those who will inherit it. That's the impetus behind our Gym in a Box, a program that puts sustainably produced ZIVA workout gear into schools where young athletes can share in our commitment to their health and to the health of the great wide world. This commitment to sustainability is a natural extension of the ZIVA Way to Live.



COMMERCIAL

Commercial quality materials and manufacturing with iconic, eye-catching design: that's been the soul of ZIVA® since the very beginning. The products in our Commercial Line are all built for the most demanding environments: gyms where clients come to be inspired, to train hard, to build better bodies, and better lives. We've made the products in this Line attractive, inspirational pieces that are rugged and durable, tough enough that gym-goers can grind out an excruciating set and drop their gear to the floor, while gym owners can feel proud watching them because they have the confidence that their equipment is made to last. From racks to rigs to bells, bumpers, bars, bags, and balls, every piece in the Commercial Line is designed to inspire, to lead users and owners to new heights of excellence and higher paths along The Way.



GLOBAL KEY ACCOUNTS

BASIC-FIT

"ZIVA is Basic Fit's preferred free weights and functional training products partner in Europe. ZIVA delivers premium quality products and customized solutions for Basic Fit and our members and supports our growth in Europe."

Rene Moos
CEO

"ZIVA offers Lift Brands a solution by ensuring access to a large range of products that our franchises love. The product and price is one of the best in the business but the extra attention, care factor and willing to truly be a partner and not just a vendor is what makes ZIVA a great company to do business with."

Andy Peat
Chief Product Officer

**snap 24/7
fitness**

smart
fit

"Smart Fit selected ZIVA to be our official and strategic partner in Brasil and all over Latin America. The ZIVA combination of innovative designs, excellent product quality and service is a winning combination for us at Smart Fit all over the continent."

Thiago Somera
Supply Chain Director

"At Anytime Fitness we value strong partnerships, and we truly treat our vendors, as partners. ZIVA's strong commitment to excellence, their values and expertise, are just some of the reasons we have chosen Ziva to support our growth across our International markets."

Patrick O'Brien
Director of International Vendor Relations

**ANYTIME
FITNESS**

Fitness First

"We enjoy a great working relationship with ZIVA, where we are always assured of conscientious and pro-active account management."

Simon Flint
CEO Evolution Wellness
Fitness First and Celebrity Fitness

"We rely on ZIVA for all our free weights and functional equipment needs. Excellent equipment, good value and great service from ZIVA at a local level. Delivery times have kept up with our aggressive build program and we are a happy customer. I like the fact ZIVA keeps evolving with the changing trends in the industry and endeavor to stay ahead of the curve."

Mike Lamb
CEO

jetts
24 hour fitness



A close-up, low-angle shot of a muscular man performing a bicep curl. He is shirtless, and his skin is glistening with sweat. He is holding a black dumbbell with both hands, and his arm is bent at the elbow. The dumbbell has the number '24' on one side and the brand name 'EVGA' on the other. The background is a blurred gym setting.

FREE WEIGHTS

The timeless training tools that have inspired fitness revolutions throughout the ages and throughout the world. Dumbbells, barbells, weight discs, and more form the foundation of strength and hypertrophy training.

ZVO

The ZVO Series of free weights represents the pinnacle of performance, design, and durability. These best-in-class workout tools feature iconic ZIVA® design, the most advanced materials and manufacturing processes, and a premium look and feel that is second to none. The ZVO Series was made especially for high-end, high-traffic commercial gyms that want the very best.

EX

When it comes to free weights, the EX Series is the best-in-class solution for storage and benches. Specially designed to deliver unparalleled ruggedness and an unquestionably premium look and feel, EX racks and benches bring the sturdiest materials and the most uniquely attractive designs to inspire gym-goers to greater intensity and greater passion for their gyms.

SL

The SL Series of dumbbells, barbells, and racks offers a range of excellent, unique designs coupled with high-quality materials and manufacturing that give each piece a high-end look and feel. The free weights in this Series speak with the same design language as the racks, making for sets that are beautiful as they are well organized.

ST

The ST Series of storage racks and benches features unique, minimalist designs crafted from thick steel tubing and plate for highly durable pieces that stay looking great despite the constant wear of high-traffic commercial gyms. This Series, with its premium look, serves as an organizational tool, a showcase, and a signpost that advertises a gym's commitment to excellence.

XP

The dumbbells, barbells, racks, and discs in the XP Series are no-nonsense, built-tough free weights and storage solutions made to withstand the most intense levels of use in high-traffic commercial gyms. This highly durable equipment is designed to meet any gym's needs, and to provide the foundations upon which great gyms are built.



ZEL

ZVO SOLID STEEL URETHANE DUMBBELLS



Solid steel head design with interlocking head to handle

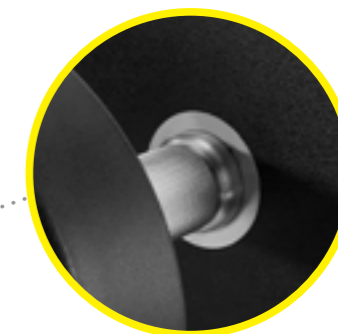

Premium hard chrome straight handle with stainless steel ring at joint



Large coloured numbers for easy weight size ID



Tested and compliant to RoHS



Premium hard wearing PU (Polyurethane)



5 year warranty

ZEL ZVO SOLID STEEL DUMBBELLS

ZIVA® ZVO Solid Steel Urethane Dumbbells use classic, iconic dumbbell design made from solid steel as a single, ultra-durable piece with long-lasting urethane-coated heads that deliver superior color accuracy and durability, and UV-, water, and tear resistance. Hard chrome-finished handles with grip-assisting knurling round out an elite design package that serves as an immediate signpost advertising a facility's continual commitment to quality and attention to detail. Available in 2kg increments.



Order Code	Item Description
ZVO-DBPU-1584-GY	ZVO Solid Steel Urethane Dumbbell Set 1-10kg (10-Pairs), 110kg
ZVO-DBPU-1631-GY	ZVO Solid Steel Urethane Dumbbell Set 12-20 kg (10 pairs), 160 kg
ZVO-DBPU-1625-GY	ZVO Solid Steel Urethane Dumbbell Set 2-20kg (10-Pairs), 220kg
ZVO-DBPU-1632-GY	ZVO Solid Steel Urethane Dumbbell Set 12-30kg (10-Pairs), 420kg
ZVO-DBPU-1633-GY	ZVO Solid Steel Urethane Dumbbell Set 22-30kg (5-Pairs), 260kg
ZVO-DBPU-1634-GY	ZVO Solid Steel Urethane Dumbbell Set 32-40kg (5-Pairs), 360kg
ZVO-DBPU-1635-GY	ZVO Solid Steel Urethane Dumbbell Set 42-50kg (5-Pairs), 460kg

Description		Solid steel head urethane dumbbell
Coating		Ultra-premium, hard-wearing urethane coating
Handle		Premium hard chrome handle with stainless steel ring at joint
Increments		1kg increments 10kg set, 2kg increments from 2kg - 50kg set
Color Options		Black / Grey
Warranty		Limited 5 year warranty

ZEL ZVO SOLID STEEL URETHANE BARBELL/EZ CURL BARBELL

The ZIVA® ZVO Solid Steel Urethane Barbell and EZ Curl Barbell update age-old straight and EZ barbell design with solid steel in a single piece with urethane-coated heads that feature striking colors that do not fade; wear, tear, UV, and water resistance; and unmatched durability. The barbells themselves feature a premium hard chrome finish and grip-assisting knurling and come in 2.5kg increments from 10-20kg, and 5kg increments from 20-45kg. Pairing this set with our ZVO Solid Steel Urethane Dumbbells gives gyms a complete free weight solution with a unified design language across every piece.



Order Code	Item Description
ZVO-BSPU-1619-GY	ZVO Solid Steel Urethane Barbell Set 10-20kg (5 pieces), 75kg
ZVO-BSPU-1580-GY	ZVO Solid Steel Urethane Barbell Set 25-45kg (5 pieces), 175kg
ZVO-BSPU-1581-GY	ZVO Solid Steel Urethane Barbell Set 10-45kg (10 pieces), 250kg
ZVO-BCPU-1601-GY	ZVO Solid Steel Urethane EZ Curl Barbell Set 10-20kg (5 pieces), 75kg
ZVO-BCPU-1582-GY	ZVO Solid Steel Urethane EZ Curl Barbell Set 25-45kg (5 pieces), 175kg
ZVO-BCPU-1583-GY	ZVO Solid Steel Urethane EZ Curl Barbell Set 10-45kg (10 pieces), 250kg

Description		ZVO solid steel urethane barbell and EZ curl barbell
Coating		Ultra-premium, hard-wearing urethane coating
Handle		Premium hard chrome handle with stainless steel ring at joint
Increments		2.5kg increments from 10kg - 20kg and 5kg increments from 20kg - 45kg
Color Options		Black / Grey
Warranty		Limited 5 year warranty

EX 5-PAIR HORIZONTAL DUMBBELL RACK

The ZIVA® EX 5-Pair Horizontal Dumbbell Rack is a best-in-class storage solution that doubles as a beautiful display rack to show off beautiful dumbbells. Glass-filled grey nylon saddles sit atop grey powder-coated steel tubes where they serve as protective cradles for round-headed dumbbells. The tubes are held aloft by welded steel plate for the perfect marriage of form and function, undeniably premium looks and beautiful organization.



Order Code
ZEX-DB05-7001

Item Description
EX 5-Pair Horizontal Dumbbell Rack

Description		EX 5-Pair Horizontal Dumbbell Rack
Specifications		Made with thick plate welded steel with reinforced load bearing internally, and -branded boards front and back. 89mm tubes support glass-filled nylon saddles
Product Color		Metallic grey powder-coated finish with black panels
Storage		Fits 5-pairs of round-head dumbbells
Dimensions		145cm x 82cm x 65cm - 65kg
Warranty		Limited 10 year warranty on frames; 1 year on saddles

EX 10-PAIR HORIZONTAL DUMBBELL RACK

The ZIVA® EX 10-Pair Horizontal Dumbbell Rack doubles the best-in-class storage of the 5-Pair Rack and shows off an even more extensive range of beautiful dumbbells. Glass-filled grey nylon saddles sit atop grey powder-coated steel tubes, cradling round-headed dumbbells in a protective cushion. The tubes are held aloft by welded steel plate for the perfect marriage of form and function, undeniably premium looks and beautiful organization.



Order Code
ZEX-DB10-7002

Item Description
EX 10-Pair Horizontal Dumbbell Rack

Description		EX 10-Pair Horizontal Dumbbell Rack
Specifications		Made with thick plate welded steel with reinforced load bearing internally, and -branded boards front and back. 89mm tubes support glass-filled nylon saddles
Product Color		Metallic grey powder-coated finish with black panels
Storage		Fits 10-pairs of round-head dumbbells
Dimensions		262cm x 82cm x 65cm - 105kg
Warranty		Limited 10 year warranty on frames; 1 year on saddles







EX 10-PIECE BARBELL RACK

The ZIVA® EX 10-Piece Barbell Rack, crafted from thick oval steel tubing, thick plate steel, and glass-filled nylon saddles, is a best-in-class storage solution that delivers an elite look and unmatched durability. This Rack, with its metallic grey coat, black panels and grey saddles, and chrome hardware lends a high-fashion feel to its surroundings while its floor-protecting footpads help keep those surroundings looking sublime.



Order Code
ZEX-BB10-7004

Item Description
EX 10-Piece Barbell Rack

Description		EX 10-Piece Barbell Rack
Specifications		Made with thick plate welded teal reinforced frame, branded boards front and back with chrome-colored hardware and glass filled nylon saddles
Product Color		 Metallic grey powder-coated finish with black panels
Storage		Fits 10-barbells or EZ curl bars
Dimensions		86cm x 122cm x 79cm - 60kg
Warranty		Limited 10 year warranty on frames; 1 year on saddles







EX 1 - 10KG VERTICAL STUDIO DUMBBELL RACK

The ZIVA® EX 1-10KG Vertical Studio Dumbbell Rack is a design masterpiece that looks perfectly at home in the most artfully designed gyms. Crafted from thick steel plate and PU saddles, though, this Rack is undeniably made for rigors of the high-traffic commercial gym where its economical use of floor space is as much of an asset as its fashionability and organizational capacity.



Order Code
ZEX-DBVS-7005

Item Description
EX 1 - 10kg Vertical Studio Dumbbell Rack

Description		EX 1 - 10kg Vertical Studio Dumbbell Rack
Specifications		Made with thick plate welded steel reinforced frame, branded boards front and back with chrome-colored hardware and PU saddles
Product Color		 Metallic grey powder-coated finish with black panels
Storage		Fits 10-pairs of round-head dumbbells
Dimensions		71cm x 163cm x 42cm - 60kg
Warranty		Limited 10 year warranty on frames and welding, 1 year on plastic parts



ZVO URETHANE GRIP DISCS

The ZIVA® ZVO Urethane Grip Disc, precision cast at 1.25kg, 2.5kg, and 5kg increments from 5-25kg, features a sleek, eye-catching design and ultra-long-lasting UV-, water-, and tear-resistant urethane coating that holds colors' vibrancy and looks newer for longer. These discs form the foundation upon which great looking, well equipped free weight sections are built, and give gym visitors the immediate impression of a full, stylishly outfitted facility.



Order Code	Item Description	Order Code	Item Description
ZVO-DCPU-1618-GY	ZVO Urethane Grip Disc 1.25kg	ZVO-DCPU-1615-GY	ZVO Urethane Grip Disc 15kg
ZVO-DCPU-1612-GY	ZVO Urethane Grip Disc 2.5kg	ZVO-DCPU-1616-GY	ZVO Urethane Grip Disc 20kg
ZVO-DCPU-1613-GY	ZVO Urethane Grip Disc 5kg	ZVO-DCPU-1617-GY	ZVO Urethane Grip Disc 25kg
ZVO-DCPU-1614-GY	ZVO Urethane Grip Disc 10kg		







Description		ZVO Urethane Grip Disc
Coating		Ultra-premium urethane surface coating
Color Options		 Black / Grey Logo & White number
Increments		1.25kg, 2.5kg with 5kg increments from 5kg - 25kg
Warranty		Limited 5 year warranty

EX DISC STORAGE STATION

The ZIVA® EX Disc Storage Station is a design masterpiece that looks just as much like a modern art piece as it does a piece of gym equipment, but crafted from thick steel plate and chrome storage posts, this Disc Storage Station is unquestionably made to stand up to the rigors of high-traffic commercial gyms where its economical use of floor space is as much of an asset as its fashionability and organizational capacity.



Order Code	Item Description
ZEX-DTVS-7006	EX Disc Storage Station

Description	 EX Disc Storage Station
Specifications	 Made with thick plate welded steel reinforced frame, branded boards front and back with chrome colored hardware and polished steel storage spindles
Product Color	  Metallic grey powder-coated finish with black panels
Storage	 Fits all ZIVA Grip Discs
Dimensions	 71cm x 124cm x 42cm - 45kg
Warranty	 Limited 10 year warranty on frames and welding, 1 year on plastic parts

ZEL ZVO URETHANE DUMBBELLS

ZIVA® ZVO Urethane Dumbbells use classic dumbbell design with long-lasting UV-, water, and tear-resistant urethane-coated heads that deliver a wide range of highly durable, highly vibrant color choices. Combined with their hard chrome-finished handles with grip-assisting knurling, these dumbbells give gym-goers an immediate sense of a facility's premium appeal. Available in 2kg increments from 2-60kg, a complete set easily meets the needs of all users, wherever they are on their fitness journey.



Order Code	Item Description
ZVO-DBPU-1301-RD	ZVO Urethane Dumbbell Set 1-10kg (10-Pairs), 110kg
ZVO-DBPU-1001-RD	ZVO Urethane Dumbbell Set 2-20kg (10-Pairs), 220kg
ZVO-DBPU-1002-RD	ZVO Urethane Dumbbell Set 12-30kg (10-Pairs), 420kg
ZVO-DBPU-1003-RD	ZVO Urethane Dumbbell Set 22-30kg (5-Pairs), 260kg
ZVO-DBPU-1004-RD	ZVO Urethane Dumbbell Set 32-40kg (5-Pairs), 360kg
ZVO-DBPU-1005-RD	ZVO Urethane Dumbbell Set 42-50kg (5-Pairs), 460kg
ZVO-DBPU-1006-RD	ZVO Urethane Dumbbell Set 52-60kg (5-Pairs), 560kg
ZVO-DBPU-1039-RD	ZVO Urethane Dumbbell Set 12-20kg (5-Pairs), 160kg

Description		ZVO Urethane Dumbbell
Coating		Ultra hard-wearing urethane coating
Handle		Premium hard chrome with stainless steel ring at joint
Increments		1kg increments 1-10kg set, 2kg increments from 2kg - 60kg set
Color Options		Black / Red
Warranty		Limited 5 year warranty

ZEL ZVO URETHANE BARBELL/EZ CURL BARBELL

The ZIVA® ZVO Urethane Barbell and EZ Curl Barbell give the old-fashioned straight and EZ barbell design a premium-styled update with striking colors that do not fade thanks to ultra-long-lasting, hard-wearing urethane coated heads. Chip-resistant hard chrome finish and grip-assisting knurling further give these pieces a premium look and feel that is immediately apparent to gym-goers. With weight increments of 2.5kg from 10-20kg, and 5kg in crements from 20-45kg, the ZVO Urethane Barbell/EZ Curl Barbell provide an excellent free weight foundation for any commercial gym looking to satisfy the needs of all their clients.



Order Code	Item Description
ZVO-BSPU-1101-RD	ZVO Urethane Barbell Set 10-20kg (5 pieces), 75kg
ZVO-BSPU-1102-RD	ZVO Urethane Barbell Set 25-45kg (5 pieces), 175kg
ZVO-BSPU-1103-RD	ZVO Urethane Barbell Set 10-45kg (10 pieces), 250kg
ZVO-BCPU-1201-RD	ZVO Urethane EZ Curl Barbell Set 10-20kg (5 pieces), 75kg
ZVO-BCPU-1202-RD	ZVO Urethane EZ Curl Barbell Set 25-45kg (5 pieces), 175kg
ZVO-BCPU-1203-RD	ZVO Urethane EZ Curl Barbell Set 10-45kg (10 pieces), 250kg

Description		ZVO Urethane Barbell and EZ Curl Barbell
Coating		Ultra hard-wearing urethane coating
Handle		Premium hard chrome with stainless steel ring at joint
Increments		2.5kg increments from 10kg - 20kg and 5kg increments from 20kg - 45kg
Color Options		Black / Red
Warranty		Limited 5 year warranty







ST 10-PAIR X-BRACE DUMBBELL RACK

The ZIVA® ST 10-Pair X-Brace Dumbbell Rack features our unique design and superior materials and craftsmanship, and perfectly nestles dumbbells in individual PVC cradles so as to immediately display their weights, and make them easily racked and unracked. The rack's feet come covered in a floor-protecting rubber covering and its X-Brace design give it maximum stability despite its minimalist look.



Order Code
ZST-DBXB-5397

Item Description
ST 10 Pair X-Brace Dumbbell Rack







Description		ST 10-Pair X-Brace Dumbbell Rack
Specifications		Horizontal style frame, forward tilted saddles, 3mm thick round tube steel and non-marking feet with option to bolt down
Product Color		 Black powder-coated finish
Storage		Fits 10-pairs of round head dumbbells
Dimensions		226cm x 80.8cm x 66.5cm - 69kg
Warranty		Limited 10 year warranty on frames and welding, 1 year on plastic parts

ST 5-PAIR HORIZONTAL DUMBBELL RACK

The ZIVA® ST 5-Pair Horizontal Dumbbell Rack features a unique design crafted from thick round steel tubing and curved weight cradles that both store and display. Dumbbells nestle perfectly so as to immediately display their weights, and are easily racked and unracked thanks to the ergonomically forward tilted shelving.



Order Code	Item Description
ZST-DBST-5392-BK	ST 5-Pair Horizontal Dumbbell Rack







Description		ST 5-Pair Horizontal Dumbbell Rack
Specifications		Horizontal style frame, forward tilted saddles, 3mm thick round tube steel and non-marking feet with option to bolt down
Product Color		 Black powder-coated finish
Storage		Fits 5-pairs of round head dumbbells
Dimensions		116cm x 80.8cm x 66.5cm - 45kg
Warranty		Limited 10 year warranty on frames and welding, 1 year on plastic parts

ST 10-PAIR HORIZONTAL DUMBBELL RACK

The ZIVA® ST 10-Pair Horizontal Dumbbell Rack doubles the length and capacity of the 5-Pair Rack but features the same unique design and superior materials and craftsmanship. Dumbbells nestle perfectly so as to immediately display their weights, and are easily racked and unracked thanks to the ergonomically forward tilted shelving.



Order Code	Item Description
ZST-DBST-5393-BK	ST 10-Pair Horizontal Dumbbell Rack

Description		ST 10-Pair Horizontal Dumbbell Rack
Specifications		Horizontal style frame, forward tilted saddles, 3mm thick round tube steel and non-marking feet with option to bolt down
Product Color		 Black powder-coated finish
Storage		Fits 10-pairs of round head dumbbells
Dimensions		226cm x 80.8cm x 66.5cm - 69kg
Warranty		Limited 10 year warranty on frames and welding, 1 year on plastic parts



ZIVA

30"
75 cm

ZIVA



61 cm **24"**

51 cm **20"**

61 cm **24"**

ST 5-PIECE BARBELL RACK

The ZIVA® ST 5-Piece Barbell Rack features an eye-catching curved design that immediately gives its load and its surroundings a higher-end feel. Crafted with 3mm thick steel tubing and featuring a scratch-, rust-, and wear-resistant black powder coat, this Rack is built to look great for longer despite the busiest, most bustling commercial gym surroundings, and its floor-protecting foodpads keep those surroundings looking great, too.



Order Code
ZST-BBRK-5390-BK

Item Description
ST 5-Piece Barbell Rack

Description		ST 5-Piece Barbell Rack
Specifications		Vertical style frame, 3mm thick round tube steel and non-marking feet with option to bolt down
Product Color		Black powder-coated finish
Storage		Fits 5 barbells or EZ curl bars
Dimensions		72cm x 132cm x 96.8cm - 37kg
Warranty		Limited 10 year warranty on frames and welding, 1 year on plastic parts

ST 10-PIECE BARBELL RACK

The ZIVA® ST 10-Piece Barbell Rack features the same eye-catching curved design as the 5-Piece Rack, but doubles the capacity. Crafted with 3mm thick steel tubing and featuring a scratch-, rust-, and wear-resistant black powder coat, this Rack is built to look great for longer despite the busiest, most bustling commercial gym surroundings, and its floor-protecting foodpads keep those surroundings looking great, too.



Order Code
ZST-BBRK-5391-BK

Item Description
ST 10-Piece Barbell Rack







Description		ST 10-Piece Barbell Rack
Specifications		Vertical style frame, 3mm thick round tube steel and non-marking feet with option to bolt down
Product Color		Black powder-coated finish
Storage		Fits 10 barbells or EZ curl bars
Dimensions		89.4cm x 131.4cm x 96.8cm - 53kg
Warranty		Limited 10 year warranty on frames and welding, 1 year on plastic parts

ZVO URETHANE GRIP DISC WITH COLOR INSERT

The ZIVA® ZVO Urethane Grip Disc with Color Insert offers a greater range of vibrant, long-lasting colors along with its sleek, eye-catching design. Precision cast at 1.25kg, 2.5kg, and 5kg increments from 5-25kg with ultra-long-lasting UV-, water-, and tear-resistant urethane coating, these discs are the basis of a great looking, well equipped free weight section, and immediately gives gym visitors the feeling of a premium, stylish facility.



Order Code	Item Description
ZVO-DCPU-1301-RD	ZVO Urethane Grip Disc with Color Insert 1.25kg
ZVO-DCPU-1302-RD	ZVO Urethane Grip Disc with Color Insert 2.5kg
ZVO-DCPU-1303-RD	ZVO Urethane Grip Disc with Color Insert 5kg
ZVO-DCPU-1304-RD	ZVO Urethane Grip Disc with Color Insert 10kg
ZVO-DCPU-1305-RD	ZVO Urethane Grip Disc with Color Insert 15kg
ZVO-DCPU-1306-RD	ZVO Urethane Grip Disc with Color Insert 20kg
ZVO-DCPU-1307-RD	ZVO Urethane Grip Disc with Color Insert 25kg

Description	 ZVO Urethane Grip Disc with Color Insert
Coating	 Premium hard-wearing polyurethane
Color Options	  Black / Red
Increments	 1.25kg, 2.5kg with 5kg increments from 5kg - 25kg
Warranty	 Limited 5 year warranty

ZVO VIRGIN RUBBER GRIP DISC

The ZIVA® ZVO Virgin Rubber Grip Disc offers a range of vibrant accent colors on its sleek, eye-catching design. Precision cast at 1.25kg, 2.5kg, and 5kg increments from 5-25kg with long-lasting, odorless, UV- and water-resistant virgin rubber coating, these discs are the basis of a well-designed, well equipped free weight section, and immediately give gym visitors the feeling of a premium, stylishly outfitted facility.



Order Code	Item Description
ZVO-DCRB-2301-RD	ZVO Virgin Rubber Grip Disc 1.25kg
ZVO-DCRB-2302-RD	ZVO Virgin Rubber Grip Disc 2.5kg
ZVO-DCRB-2303-RD	ZVO Virgin Rubber Grip Disc 5kg
ZVO-DCRB-2304-RD	ZVO Virgin Rubber Grip Disc 10kg
ZVO-DCRB-2305-RD	ZVO Virgin Rubber Grip Disc 15kg
ZVO-DCRB-2306-RD	ZVO Virgin Rubber Grip Disc 20kg
ZVO-DCRB-2307-RD	ZVO Virgin Rubber Grip Disc 25kg

Description		ZVO Virgin Rubber Grip Disc
Coating		Premium hard-wearing rubber
Color Options		Black / Red
Increments		1.25kg, 2.5kg with 5kg increments from 5kg - 25kg
Warranty		Limited 2 year warranty

ST DISC STORAGE RACK

The ZIVA® ST Disc Storage Rack is built tough with thick steel tubing, scratch-, wear-, and rust-resistant black powder coating, and 6x polished steel storage posts. This Rack keeps high-traffic commercial gyms uncluttered and organized for a higher-end look and feel that makes it easier for users to feel inspired. With its rugged look and ability to hold up to 25kg plates, it's a must-have alongside squat racks, benches, and lifting platforms.



Order Code	Item Description
ZST-ODRK-5394-BK	ST Disc Storage Rack



Description		ST Disc Storage Rack
Specifications		Vertical style frame, holds all ZIVA grip discs. Comes with non-marking feet with option to bolt down and polished steel storage spindles
Product Color		Black powder-coated finish
Storage		Stores up to 25kg Olympic grip discs
Dimensions		73.3cm x 110cm x 62cm - 33kg
Warranty		Limited 10 year warranty on frames and welding, 1 year on plastic parts

ZEL ZVO URETHANE FUNCTIONAL TRIBELL

The innovative and iconic ZIVA® tribell design offers a sleek look while keeping the bells from rolling away. With an ultra-durable, scratch-, tear-, and scuff-resistant urethane coating, the ZVO Urethane Functional Tribell is a best-in-class piece that's both compact and stable, sticking in sweaty hands thanks to grippy urethane knurling, making them the perfect solution for light resistance group classes that serve as a major draw for many gyms.



Order Code	Item Description	Order Code	Item Description
ZVO-PUTF-3070-BKWT	ZVO Urethane Functional Tribell 1kg	ZVO-PUTF-3076-BKWT	ZVO Urethane Functional Tribell 7kg
ZVO-PUTF-3071-BKWT	ZVO Urethane Functional Tribell 2kg	ZVO-PUTF-3078-BKWT	ZVO Urethane Functional Tribell 8kg
ZVO-PUTF-3072-BKWT	ZVO Urethane Functional Tribell 3kg	ZVO-PUTF-3079-BKWT	ZVO Urethane Functional Tribell 9kg
ZVO-PUTF-3073-BKWT	ZVO Urethane Functional Tribell 4kg	ZVO-PUTF-3080-BKWT	ZVO Urethane Functional Tribell 10kg
ZVO-PUTF-3074-BKWT	ZVO Urethane Functional Tribell 5kg	ZVO-PUTF-3081-BKWT	ZVO Urethane Functional Tribell 1kg - 10kg Set
ZVO-PUTF-3075-BKWT	ZVO Urethane Functional Tribell 6kg		

Description		ZVO Urethane Functional Tribell
Coating		Premium hard-wearing urethane coating
Increments		1kg increments
Color Options		Black & White
Warranty		Limited 2 year warranty

ST 1-10KG STUDIO DUMBBELL RACK

The ZIVA® ST 1-10KG Studio Dumbbell Rack features an eye-catching curved design that immediately gives its powder coat; floor-protecting foodpads; and PU-cushioned saddles, this rack is built to be a long-lasting, beautiful display piece with the organizational ability to keep its surroundings beautiful, too.



Fits 1-10kg Urethane Studio Dumbbells, 1-10kg Urethane Tribells, 1-10kg Hexagon Dumbbells and 1-10kg Performance Virgin Rubber Dumbbells



Order Code	Item Description
ZST-VS10-5396-BK	ST 1-10kg Studio Dumbbell Rack

Description		ST 1-10kg Studio Dumbbell Rack
Specifications		Compact vertical dumbbell rack with minimal footprint, PU cushioned saddles, steel saddles and non-marking feet with option to bolt down
Product Color		Black powder-coated finish
Storage		Fits 1kg - 10kg studio dumbbells or tribells
Dimensions		153.5cm x 92cm x 54cm - 50kg
Warranty		Limited 10 year warranty on frames and welding, 1 year on plastic parts

ST 20 PAIR 1-10KG STUDIO DUMBBELL RACK

The ZIVA® ST 20 Pair 1-10KG Studio Dumbbell Rack with its eye-catching and iconic curved design is extended to hold 20x pairs of tribells or dumbbells of any variety. Just like the 10-pair rack, it features a rust- and scratch-resistant black powder coat, PU-cushioned saddles, and floor-protecting footpads, and just like its smaller version, it is equal parts beautiful display and organizational tool.



Fits 1-10kg Urethane Studio Dumbbells, 1-10kg Urethane Tribells, 1-10kg Performance Virgin Rubber Dumbbells and 1-10 Neoprene Tribells



Order Code	Item Description
ZST-DBST-1835-BK	ST 20 Pair 1-10kg Studio Dumbbell Rack

Description		ST 20 Pair 1-10kg Studio Dumbbell Rack
Specifications		Compact vertical dumbbell rack with minimal footprint, PU cushioned saddles, steel saddles and non-marking feet with option to bolt down
Color Options		Black powder-coated finish
Storage		Fits 1kg - 10kg studio dumbbells or tribells
Dimensions		112cm x 71 cm x 142cm - 77kg
Warranty		Limited 10 year warranty on frames and welding, 1 year on plastic parts

EX F-I-D BENCH

The ZIVA® EX F-I-D Bench is a best-in-class, uniquely designed wonder of versatility, stability, and comfort. With 2x points of adjustment at the seat bottom and back, this F-I-D Bench allows users to enjoy a wide variety of chest, shoulder, and other exercises in the utmost security and safety, and thanks to its high-quality cushions with high durability double stitching, they can enjoy the utmost comfort, as well.



Order Code
ZEX-XFID-6762

Item Description
EX F-I-D Bench

Description		EX F-I-D Bench
Specifications		3.0mm thick steel frame, adjustable seat bottom (0-30°) & back (-10-80°), cushioned rubber feet or bolt down option, high quality cushion surface with double stitches for better stability
Weight Loading		200kg
Product Color		Black powder-coated finish
Dimensions		140cm x 60cm x 55cm - 40kg
Warranty		Limited 10 year warranty on frames and welding, 1 year on plastic parts, 90 days on pads

EX FLAT BENCH

The ZIVA® EX Flat Bench, with its unmistakable design, high quality double-stitched cushion, and supremely stable structure, is the best-in-class choice for any fixed flat bench. It features a 3mm thick steel frame with scratch-, rust-, and wear-resistant black powder coating that makes it exceedingly durable, so it stays looking newer for longer despite the rigorous environments of heavy weight areas in high-traffic commercial gyms.



Order Code
ZEX-XFLT-6752

Item Description
EX Flat Bench

Description		EX Flat Bench
Specifications		3.0mm thick steel frame, cushioned rubber feet with bolt down option, high quality cushion surface with double stitches for better stability
Weight Loading		200kg
Product Color		Black powder-coated finish
Dimensions		135cm x 80cm x 40cm - 30kg
Warranty		Limited 10 year warranty on frames and welding, 1 year on plastic parts, 90 days on pads









EX ABDOMINAL BENCH

The ZIVA® EX Abdominal Bench, set at a 30° incline, is a marvel of minimalist design. Its 3mm thick steel frame, floor-protecting rubber feet, and high quality, double-stitched cushion are all it needs to be a best-in-class core workout mainstay that both looks and feels great, so users only experience the pain of their intense workout.



Order Code
ZEX-XABD-9894

Item Description
EX Abdominal Bench

Description		EX Abdominal Bench
Specifications		3.0mm thick steel frame, 30° back angle for comfort and safety, cushioned rubber feet with bolt down option and high quality cushion surface with double stitches for better stability
Weight Loading		200kg
Product Color		 Black powder-coated finish
Dimensions		127cm x 63cm x 83cm - 32kg
Warranty		Limited 10 year warranty on frames and welding, 1 year on plastic parts, 90 days on pads



EX HYPER EXTENSION BENCH

The ZIVA® EX Hyper Extension Bench is the ultimate in stability, style, and comfort. Its heavy-duty, 3mm thick steel frame and rubber feet keep it firmly in place even as users adjust the high quality cushion height and lock in on the polished steel foot plate or use the built-in bars. However it's used, this Hyper Extension Bench delivers an undeniably premium look and feel that enhances the surrounding environment of any gym its in.



Order Code
ZEX-XHEX-6764

Item Description
EX Hyper Extension Bench

Description		EX Hyper Extension Bench
Specifications		3.0mm thick steel frame, cushioned rubber feet with bolt down option, adjustable pad height and high quality cushion surface with double stitches for better stability
Weight Loading		200kg
Product Color		Black powder-coated finish
Dimensions		150cm x 90cm x 110cm - 45kg
Warranty		Limited 10 year warranty on frames; 90 days on pads

EX SCOTT CURL BENCH

The ZIVA® EX Scott Curl Bench lets users lock arms in place for more intense, targeted arm exercises. The bench's 3mm thick, heavy steel frame and floor-gripping and -protecting rubber feet ensure stability at any weight, while its high quality cushions for the arms and on the adjustable seat ensure comfort, as well. A bench uniquely designed to help grow arms, it is a must for any gym's heavy weight lifting zone.



Order Code
ZEX-XSCT-6758

Item Description
EX Scott Curl Bench

Description		EX Scott Curl Bench
Specifications		3.0mm thick steel frame, cushioned rubber feet with bolt down option, hard-wearing padding, adjustable seat height to enable multiple exercise positions, and hard-wearing PU padding and strips to protect the metal surfaces and barbell knurling
Weight Loading		200kg
Product Color		Black powder-coated finish
Dimensions		140cm x 90cm x 90cm - 65kg
Warranty		Limited 10 year warranty on frames; 90 days on pads









SL RPU GRIP DISC

The ZIVA® SL RPU Grip Disc wraps our precision cast iron weight disc in high durability RPU that has enough give to fall more softly and silently, yet has the ruggedness to stand up to the rigors of high-traffic commercial gyms. Available in 1.25kg and 2.5kg sizes, and in 5kg increments from 5-25kg and made to fit any standard Olympic bar, the RPU Grip Disc is scratch-, wear-, and rust-resistant and comes in vibrant colors.



Order Code	Item Description	Order Code	Item Description
ZSL-DCPU-2640	SL RPU Grip Disc 1.25kg	ZSL-DCPU-2644	SL RPU Grip Disc 15kg
ZSL-DCPU-2641	SL RPU Grip Disc 2.5kg	ZSL-DCPU-2645	SL RPU Grip Disc 20kg
ZSL-DCPU-2642	SL RPU Grip Disc 5kg	ZSL-DCPU-2646	SL RPU Grip Disc 25kg
ZSL-DCPU-2643	SL RPU Grip Disc 10kg		

Description		SL RPU Grip Disc
Coating		Premium rubberized polyurethane surface coating
Color Options		<input type="checkbox"/> Black / Grey logo & Grey number <input checked="" type="checkbox"/> Black / Black logo & Black number
Increments		1.25kg, 2.5kg and 5kg increments from 5kg - 25kg
Warranty		Limited 2 year warranty



ZIVVA
BOXING
— LEGENDARY —



SL PREMIUM HEXAGON VIRGIN RUBBER DUMBBELLS



Premium virgin rubber coating



Premium chrome handle



Steel cores



Patented design



Tested and compliant to RoHS



Large coloured numbers for easy weight size ID









2 year warranty

ZEL SL PREMIUM HEXAGON VIRGIN RUBBER DUMBBELLS

The ZIVA® SL Premium Hexagon Virgin Rubber Dumbbell Set uses a convenient, no-roll dumbbell design for enhanced safety; long-lasting, odor-free rubber-coated heads; chrome-finished handles with grip-assisting knurling; and large, easy ID weight numbers. Available in 1kg increments from 1-10kg and 2kg increments from 10-50kg, this highly durable strength training tool gives the free weight section a premium look and feel.



Order Code	Item Description	Order Code	Item Description
ZSL-PRHD-6014	SL Premium Hexagon Virgin Rubber Dumbbell Set 1-10kg (10 Pairs)	ZSL-PRHD-6060	SL Premium Hexagon Virgin Rubber Dumbbell 22kg
ZSL-PRHD-6050	SL Premium Hexagon Virgin Rubber Dumbbell 2kg	ZSL-PRHD-6061	SL Premium Hexagon Virgin Rubber Dumbbell 24 kg
ZSL-PRHD-6076	SL Premium Hexagon Virgin Rubber Dumbbell 3kg	ZSL-PRHD-6062	SL Premium Hexagon Virgin Rubber Dumbbell 26 kg
ZSL-PRHD-6051	SL Premium Hexagon Virgin Rubber Dumbbell 4kg	ZSL-PRHD-6063	SL Premium Hexagon Virgin Rubber Dumbbell 28 kg
ZSL-PRHD-6077	SL Premium Hexagon Virgin Rubber Dumbbell 5kg	ZSL-PRHD-6064	SL Premium Hexagon Virgin Rubber Dumbbell 30 kg
ZSL-PRHD-6052	SL Premium Hexagon Virgin Rubber Dumbbell 6kg	ZSL-PRHD-6065	SL Premium Hexagon Virgin Rubber Dumbbell 32 kg
ZSL-PRHD-6078	SL Premium Hexagon Virgin Rubber Dumbbell 7kg	ZSL-PRHD-6066	SL Premium Hexagon Virgin Rubber Dumbbell 34 kg
ZSL-PRHD-6053	SL Premium Hexagon Virgin Rubber Dumbbell 8kg	ZSL-PRHD-6067	SL Premium Hexagon Virgin Rubber Dumbbell 36 kg
ZSL-PRHD-6079	SL Premium Hexagon Virgin Rubber Dumbbell 9kg	ZSL-PRHD-6068	SL Premium Hexagon Virgin Rubber Dumbbell 38 kg
ZSL-PRHD-6054	SL Premium Hexagon Virgin Rubber Dumbbell 10kg	ZSL-PRHD-6069	SL Premium Hexagon Virgin Rubber Dumbbell 40 kg
ZSL-PRHD-6055	SL Premium Hexagon Virgin Rubber Dumbbell 12kg	ZSL-PRHD-6070	SL Premium Hexagon Virgin Rubber Dumbbell 42 kg
ZSL-PRHD-6056	SL Premium Hexagon Virgin Rubber Dumbbell 14kg	ZSL-PRHD-6071	SL Premium Hexagon Virgin Rubber Dumbbell 44 kg
ZSL-PRHD-6057	SL Premium Hexagon Virgin Rubber Dumbbell 16kg	ZSL-PRHD-6072	SL Premium Hexagon Virgin Rubber Dumbbell 46 kg
ZSL-PRHD-6058	SL Premium Hexagon Virgin Rubber Dumbbell 18kg	ZSL-PRHD-6073	SL Premium Hexagon Virgin Rubber Dumbbell 48 kg
ZSL-PRHD-6059	SL Premium Hexagon Virgin Rubber Dumbbell 20kg	ZSL-PRHD-6074	SL Premium Hexagon Virgin Rubber Dumbbell 50 kg







Description		SL Premium Hexagon Virgin Rubber Dumbbell
Coating		Premium virgin rubber surface coating
Handle		Premium chrome handles
Color Options		 Black / Yellow logo & Grey number
Increments		1kg increments from 1kg - 10kg and 2kg increments from 10kg - 50kg
Warranty		Limited 2 year warranty

ST2 10-PAIR 3-TIER HEXAGON DUMBBELL RACK

The ZIVA® ST2 10-Pair 3-Tier Hexagon Dumbbell Rack features heavy-duty oval steel tubing and floor-protecting rubber-covered feet to keep surroundings pristine. Weights are kept well-organized and exactly where they are needed, and are easy to remove and replace thanks to slightly sloped shelves with a saddleless design that offers a wide diversity of storage options.



Order Code	Item Description
ZST-DBST-5410-BK	ST2 10 Pair 3-Tier Hexagon Dumbbell Rack (Without Saddle)

Description		ST2 10 Pair 3-Tier Hexagon Dumbbell Rack (Without Saddle)
Specifications		Vertical style frame, 3mm thick round tube steel and non-marking feet with option to bolt down
Color Options		 Black powder-coated finish
Storage		Fits 10-pairs of round head dumbbells 2-20kg
Dimensions		120cm x 66.8cm x 86.7cm - 48kg
Warranty		Limited 10 year warranty on frames and welding, 1 year on plastic parts





XP URETHANE DUMBBELLS



Solid steel head design with interlocking head to handle

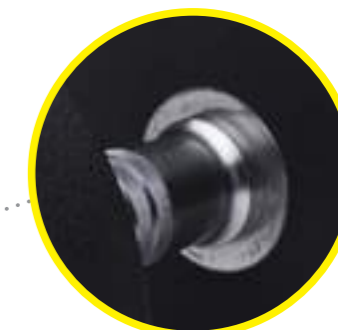

Premium hard chrome contoured handle with stainless steel ring at joint



Large coloured numbers for easy weight size ID



Tested and compliant to RoHS



Premium hard wearing TPU (Thermoplastic Polyurethane)



3 year warranty









ZEL XP URETHANE DUMBBELLS

The ZIVA® XP Urethane Dumbbells take the simplest, most classic dumbbell design and update it with long-lasting UV-, water-, and tear-resistant urethane-coated heads and white+black or iconic ZIVA black+yellow color options. With hard chrome-finished contoured handles and grip-assisting knurling, these dumbbells are a no-nonsense update on a timeless classic, and come in 2.5kg increments from 2.5-60kg, or 2kg increments from 2-60kg.



Order Code	Item Description
ZXP-DBPU-1000	XP Urethane Dumbbell Set (10-Pairs) 1-10kg
ZXP-DBPU-8688	XP Urethane Dumbbell Set (25 Pairs) 2-50kg
ZXP-DBPU-8686	XP Urethane Dumbbell Set (10 Pairs) 2-20kg
ZXP-DBPU-8685	XP Urethane Dumbbell Set (10 Pairs) 22-40kg
ZXP-DBPU-8658	XP Urethane Dumbbell Set (5 Pairs) 42-50kg
ZXP-DBPU-7719	XP Urethane Dumbbell Set (20 pairs) 2.5-50kg
ZXP-DBPU-7720	XP Urethane Dumbbell Set (10-Pairs) 27.5-50kg
ZXP-DBPU-8000	XP Urethane Dumbbell Set (4 pairs) 52.5-60kg







Description		XP Solid Steel Head Urethane Dumbbell
Coating		Premium urethane surface coating
Handle		Premium contoured hard chrome handle
Increments		1kg increments 1-10kg set, 2.5kg increments from 2.5kg - 60kg and 2kg increments from 2kg - 60kg
Color Options		 Black / White
Warranty		Limited 3 year warranty

ZEL XP URETHANE BARBELLS / EZ CURL BARBELLS

The ZIVA® XP Urethane Barbell and EZ Curl Barbell speak the unmistakable ZIVA design language while taking an updated approach to this timeless classic with long-lasting UV-, water-, and tear-resistant urethane-coated heads. Chip-resistant hard chrome finish and grip-assisting knurling on the bars round out this complete package, available in weight increments of 2.5kg from 10-20kg, or 5kg from 20-45kg.



Order Code	Item Description
ZXP-BSPU-8110	XP Urethane Barbell Set (5 pieces) 10-20kg, 75kg
ZXP-BSPU-8111	XP Urethane Barbell Set (5 pieces) 25-45kg, 175kg
ZXP-BSPU-8112	XP Urethane Barbell Set (10 pieces) 10-45kg, 250kg
ZXP-BCPU-8125	XP Urethane EZ Curl Barbell Set (5 pieces) 10-20kg, 75kg
ZXP-BCPU-8126	XP Urethane EZ Curl Barbell Set (5 pieces) 25-45kg, 175kg
ZXP-BCPU-8127	XP Urethane EZ Curl Barbell Set (10 pieces) 10-45kg, 250kg

Description		XP Urethane Barbell and EZ Curl Barbell
Coating		Premium urethane surface coating
Handle		Premium hard chrome handle
Increments		2.5kg increments from 10kg - 20kg and 5kg increments from 20kg - 45kg
Color Options		 Black / White
Warranty		Limited 3 year warranty







XP 5-PAIR DUMBBELL RACK WITH SADDLES

The ZIVA® XP 5-Pair Dumbbell Rack with Saddles is a no-nonsense storage solution that features hard-wearing 75 x 75mm steel tubing and curved weight cradles that perfectly nestle dumbbells for immediate weight number display. The ergonomically tilted cradles and shelves make racking and unracking easy, fast, and safe.



Order Code
ZXP-DBST-5909

Item Description
XP 5-Pair Dumbbell Rack with Saddles

Description		XP 5-Pair Dumbbell Rack with Saddles
Specifications		Made with 75mm x 75mm tubing, horizontal style frame, forward tilted saddles and non-marking feet with option to bolt down
Product Color		 Black powder-coated finish
Storage		Fits 5-pairs of round head dumbbells
Dimensions		120cm x 66.8cm x 86.7cm - 48kg
Warranty		Limited 10 year warranty on frames and welding, 1 year on plastic parts



XP 10-PAIR DUMBBELL RACK WITH SADDLES

The ZIVA® XP 10-Pair Dumbbell Rack with Saddles expands on the 8-Pair Rack and features the same no-nonsense, hard-wearing 75 x 75mm steel tubing and curved weight cradles that perfectly nestle dumbbells to display their weights, and are easily racked and unracked thanks to the ergonomically forward tilted shelving.



Order Code
ZXP-DBST-5908

Item Description
XP 10-Pair Dumbbell Rack with Saddles

Description		XP 10-Pair Dumbbell Rack with Saddles
Specifications		Made with 75mm x 75mm tubing, horizontal style frame, forward tilted saddles and non-marking feet with option to bolt down
Product Color		Black powder-coated finish
Storage		Fits 10-pairs of round-head dumbbells
Dimensions		240cm x 66.8cm x 86.7cm - 70kg
Warranty		Limited 10 year warranty on frames and welding, 1 year on plastic parts

XP BARBELL RACK

The ZIVA® XP Barbell Rack is a no-nonsense barbell and EZ bar storage station. This Barbell Rack uses tough-built 75 x 75mm steel tubing with a scratch-resistant black powder coating and glass-filled nylon saddles attached with chromed hardware. This piece is built to last and stay looking great in even the busiest commercial gyms.



Order Code
ZXP-BBRK-4699

Item Description
XP Barbell Rack

Description		XP Barbell Rack
Specifications		Made with 75mm x 75mm tubing, vertical style frame, hard-wearing glass filled nylon saddles and non-marking feet with option to bolt down
Product Color		Black powder-coated finish
Storage		Fits 10 barbells or EZ curl bars
Dimensions		71cm x 60cm x 159cm - 41kg
Warranty		Limited 10 year warranty on frames and welding, 1 year on plastic parts







XP PLATE TREE (18 PIECES)

The ZIVA® XP Plate Tree is a no-nonsense storage solution crafted from thick steel tubing with a scratch-, wear, and rust-resistant black powder coating and 6x polished steel storage posts. This Rack keeps high-traffic commercial gyms uncluttered and organized. With its ability to hold up to 25kg plates, it's a rugged must-have alongside squat racks, benches, and lifting platforms where its load is needed most.



Order Code
ZXP-ODRK-4015

Item Description
XP Plate Tree (18 pieces)

Description		XP Plate Tree (18 pieces)
Specifications		Made with 75mm x 75mm tubing, vertical plate tree able to hold all ZIVA grip discs designs
Product Color		 Black powder-coated finish
Storage		Stores up to 25kg Olympic discs
Dimensions		71cm x 67cm x 135cm - 34kg
Warranty		Limited 10 year warranty on frames and welding, 1 year on plastic parts





FUNCTIONAL

Beautifully built functional fitness equipment designed to inspire. Balls, bags, boxes, bars, and every piece of essential equipment for the modern functionally focused premium fitness facility.

OZVO

The functional ZVO Series, featuring bells, bags, balls, barbells, bumpers, and more, is the best-in-class for the foundations of functional training. The pieces in this Series are all specially designed to not only withstand the rigors of high-traffic commercial gyms, but to do so with superior look, feel, and performance. They are the elite tools that make tried-and-true functional fitness exercises possible.

EX

The EX Series offers a specially designed mix of premium functional stations and storage racks. The functional stations are customizable gym centerpieces that combine functional fitness features with flexible storage solutions. The storage racks are built to maximize available floor space, keep gyms clean and uncluttered, and feature protective PVC-lined shelving that are display cases just as much as they are organizational hubs.

SL

The SL Series brings incredible durability and design to the basic building blocks of functional fitness workouts. The pieces in this Series represent the core equipment necessary for intense, full-body work, and have been made with superior materials and always attractive ZIVA® design to give users a tool that inspires.

ST

The storage racks in the ST Series are beautifully designed displays that give the most attractive functional fitness tools an organized home worthy of them. Made with thick steel plate and tubing, these high durability racks keep everything in its place for an uncluttered, always clean gym.

XP

The pieces in the XP Series are no-nonsense, built-tough storage and functional fitness solutions made to withstand the most intense usage environments in high-traffic commercial gyms. This highly durable equipment is designed to meet any gym's needs, and to provide the foundations of a great workout.

SIGNATURE

The Signature Series contains elite functional fitness pieces that make a statement: we are committed to working with the very best athletes and equipment. Made in collaboration with the fitness visionaries that made these tools the mainstays they are today, every piece in the Signature Series offers the ultimate in performance, look, and feel.









ZEL ZEP EX FUNCTIONAL TRAINING STATION

The ZIVA® EX Functional Training Station offers the ultimate combination of storage, display, stretching, and training. A central pull-up bar allows for several grip variations; 8x adjustable PVC-lined shelves store and display functional training equipment; 2x vertical bars serve as anchors for rope and stretching; 2x specialized suspension trainer anchors round out its offering; and a TV bracket lets gyms turn this into a total training solution. Precision designed to transform typically wasted corners into premium athletic attractions, the EX Functional Training Station serves as an immediate signal to all visitors that a gym is head and shoulders above the competition.



Order Code
ZEX-SSMF-0770

Item Description
EX Functional Training Station

Description		EX Functional Training Station
Specifications		200mm wide main frame, full commercial 3mm thick steel, 16mm bolts, floor mounted with safety extensions for extra stability, hard-wearing powder coating <i>Note: Shelving positions can be changed to suit your own set up</i> With pull-up bar, 2 x suspension points, 2 x rope pull bars, TV Bracket (TV not included)
Product Color		 Charcoal powder-coated finish
Storage		Fits wall balls, medicine balls, power core bags, slam balls, kettlebells, dumbbells, and all small accessories
Dimensions		331cm x 210cm x 235cm - 440kg
Warranty		Limited 10 year warranty on frames and welding, 1 year on plastic parts

ZEL ZEP EX FUNCTIONAL STRETCH STATION

The ZIVA® EX Functional Stretch Station transforms often underutilized corner spaces into stretching and cooldown hotspots. The Station offers shelf space for storage and display; a versatile stretching ladder that allows for stretching from nearly any angle; 2x specialized suspension trainer anchors; 2x vertical bars for anchoring ropes or other equipment, or for stretching; brackets for mat storage; a pull-up bar; and TV bracket that lets gyms turn this Station into a digital personal trainer. With heavy-duty 3mm thick steel construction and scratch- and wear-resistant black powder coating, this is an athletic attraction that is built to last.



Order Code
ZEX-SSMF-0771

Item Description
EX Functional Stretch Station

Description		EX Functional Stretch Station
Specifications		200mm wide main frame, full commercial 3mm thick steel, 16mm bolts, floor mounted with safety extensions for extra stability, hard-wearing powder coating <i>Note: Shelving positions can be changed to suit your own set up</i> With pull-up bar, 2 x suspension points, 2 x rope pull bars, TV Bracket (TV not included)
Product Color		Charcoal powder-coated finish
Storage		Fits yoga balls, balance balls, mats, small accessories
Dimensions		331cm x 210cm x 235cm - 390kg
Warranty		Limited 10 year warranty on frames and welding, 1 year on plastic parts

EX FUNCTIONAL CORNER

The ZIVA® EX Functional Corner is a stretching center with built-in racks; a storage hub with room for a variety of balls, bags and bells; a multi-person bodyweight training station with pull-up bar and a multitude of hanging positions; and is a suspension training base with anchors at every conceivable angle. Ultimately, though, it is more than the sum of its parts. It serves as an immediate, eye-catching signal to gym-goers that this is a facility that will help them take functional fitness training to elite levels, and do so with premium aesthetics that inspire.

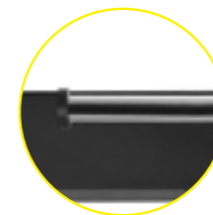

Straight pull-up and suspension attachment bar



Secure band and accessory attachment points



Hard-wearing shelving fits all manner of accessories

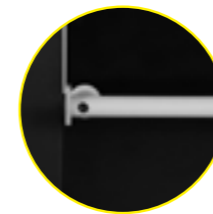

Permanent shelf supports bolted in place for added safety

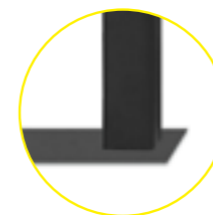





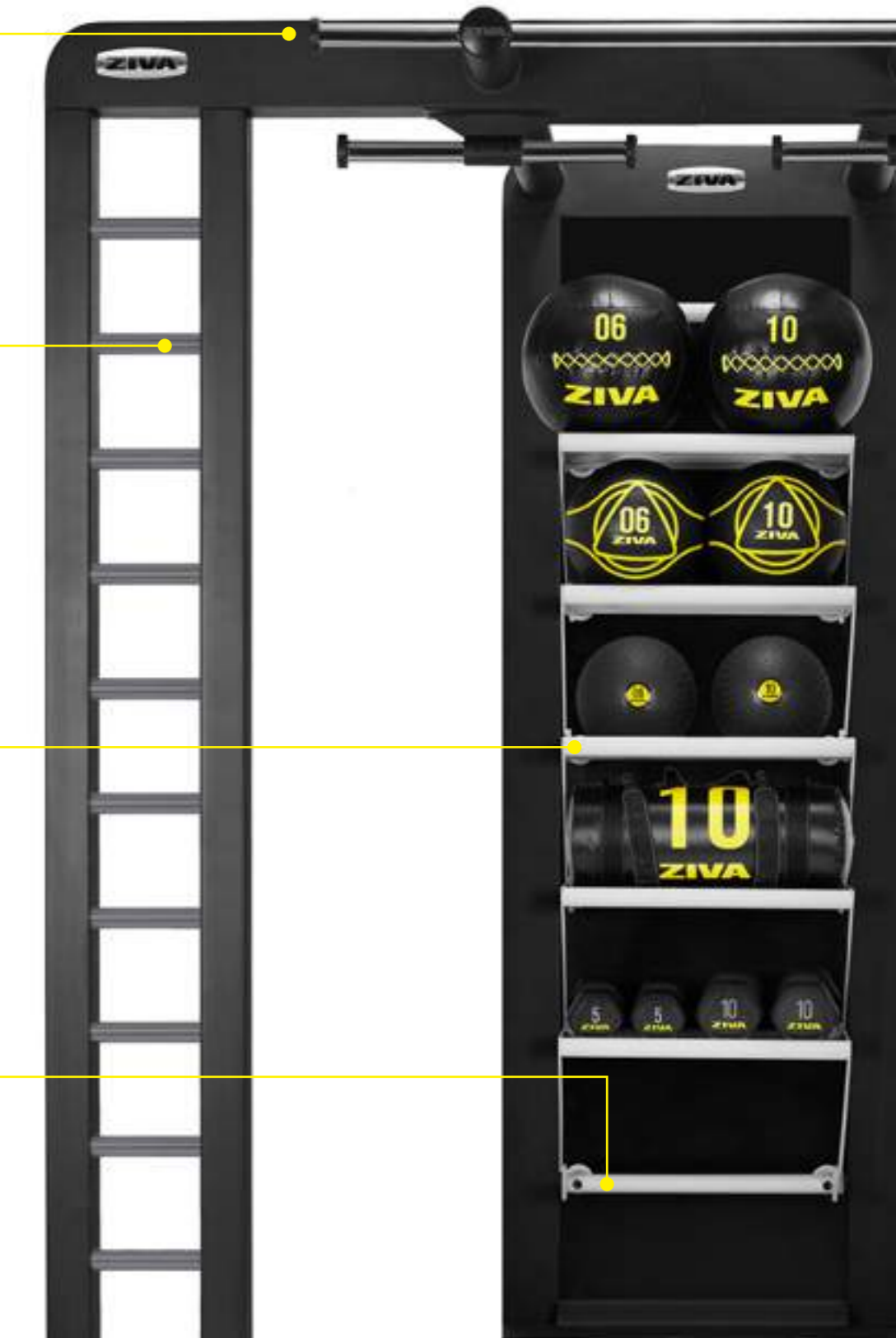

Thick steel base plate bolted to floor for maximum stability

**Must be bolted to floor*



Order Code
ZEX-XCRN-5175

Item Description
EX Functional Corner

Description		EX Corner
Specifications		Made with steel tubing, thick plate steel, welded frames, black with grey-colored shelving and pull-up bars
Product Color		Black powder-coated finish. Shelves and pull up bars are grey-colored
Storage		Fits wall balls, medicine balls, power core bags, slam balls, and dumbbells, and all small accessories
Dimensions		230cm x 183cm x 243cm - 400kg
Warranty		Limited 10 year warranty on frames and welding, 1 year on plastic parts



EX FUNCTIONAL WALL STORAGE 120

The ZIVA® EX Wall Storage 120 offers commercial gyms an expanded storage solution that makes the most out of floorspace while serving as a functional display case and delivering a premium aesthetic. Crafted with heavy-duty steel tubing, and thick plate steel with reinforced welds across its frame, its 5x PVC-lined shelves bring twice as much storage space as its little brother and allow for storage and display of balls, bags, and bells as needed.









Order Code

ZFT-XWMT-5295

Item Description

EX Functional Wall Storage 120

Description		EX Functional Wall Storage 120
Specifications		Made with steel tubing, thick plate steel, welded frames, black with grey-colored hardware
Product Color		 Black & grey powder-coated finish
Storage		Fits wall balls, medicine balls, power core bags, slam balls, and dumbbells
Dimensions		120cm x 20cm x 190cm - 121kg
Warranty		Limited 10 year warranty on frames and welding, 1 year on plastic parts

ZEL ZVO MEDICINE BALLS

The ZVO Medicine Ball takes this timeless tool and wraps it in modern technology with easy-grip textured rubber and vibrantly colored, easy to ID numbering. Available in 1kg increments from 2-10kg, this precision-weighted piece is the tried-and-true cornerstone for most functional fitness workouts, helping build total body strength, explosivity, and sport-specific power for results that keep gym-goers coming back.



Order Code	Item Description	Order Code	Item Description
ZVO-CMMB-9061-YL	ZVO Medicine Ball 2kg	ZVO-CMMB-9066-YL	ZVO Medicine Ball 7kg
ZVO-CMMB-9062-YL	ZVO Medicine Ball 3kg	ZVO-CMMB-9067-YL	ZVO Medicine Ball 8kg
ZVO-CMMB-9063-YL	ZVO Medicine Ball 4kg	ZVO-CMMB-9068-YL	ZVO Medicine Ball 9kg
ZVO-CMMB-9064-YL	ZVO Medicine Ball 5kg	ZVO-CMMB-9069-YL	ZVO Medicine Ball 10kg
ZVO-CMMB-9065-YL	ZVO Medicine Ball 6kg		







Description		ZVO Medicine Ball
Specifications		Made with premium rubber
Color Options	  Black / Yellow  Black / Grey	
Increments		1kg increments from 2kg - 10kg
Warranty		Limited 1 year warranty

ZEL ZVO DUAL GRIP MEDICINE BALL

The ZIVA® ZVO Dual Grip Medicine Ball takes this timeless training tool and brings it into the modern age with precision-calibrated weighting; a premium-quality, textured rubber coat; easy-grip handles on either side; and vibrantly colored, easy to ID numbering. An essential piece for any functional fitness area, the Grip Medicine Ball provides a versatility that empowers explosive, full-body workouts as well as sport-specific training and general physical fitness



Order Code	Item Description	Order Code	Item Description
ZVO-DGMB-9230-YL	ZVO Dual Grip Medicine Ball 3kg	ZVO-DGMB-9234-YL	ZVO Dual Grip Medicine Ball 7kg
ZVO-DGMB-9231-YL	ZVO Dual Grip Medicine Ball 4kg	ZVO-DGMB-9235-YL	ZVO Dual Grip Medicine Ball 8kg
ZVO-DGMB-9232-YL	ZVO Dual Grip Medicine Ball 5kg	ZVO-DGMB-9236-YL	ZVO Dual Grip Medicine Ball 9kg
ZVO-DGMB-9233-YL	ZVO Dual Grip Medicine Ball 6kg	ZVO-DGMB-9237-YL	ZVO Dual Grip Medicine Ball 10kg

Description		ZVO Dual Grip Medicine Ball
Specifications		Made with premium rubber
Color Options	  Black / Yellow  Black / Grey	
Increments		1kg increments from 3kg - 10kg
Warranty		Limited 1 year warranty









ZEL ZVO SLAM BALL

Full-body strength and endurance; intense, explosive cardio; and challenging rotational core exercises combine in one durable, elite-level tool guaranteed to push performance to its absolute limits. The ZVO Slam Ball features a weighted, sand-filled center wrapped in a tough PVC shell with gripping tire tread skin, and is made to be thrown with abandon over and over again. Overhead slams, woodchoppers, Russian twists, and more unique full-body exercises test the limits of users' core strength and endurance while building shoulder, chest, arm, and leg muscle in a holistic fashion that includes often neglected supporting and stabilizer muscles.



Order Code	Item Description	Order Code	Item Description
ZVO-SPSB-6870	ZVO Slam Ball 2kg	ZVO-SPSB-6878	ZVO Slam Ball 10kg
ZVO-SPSB-6871	ZVO Slam Ball 3kg	ZVO-SPSB-6879	ZVO Slam Ball 12kg
ZVO-SPSB-6872	ZVO Slam Ball 4kg	ZVO-SPSB-6880	ZVO Slam Ball 15kg
ZVO-SPSB-6873	ZVO Slam Ball 5kg	ZVO-SPSB-6881	ZVO Slam Ball 18kg
ZVO-SPSB-6874	ZVO Slam Ball 6kg	ZVO-SPSB-6882	ZVO Slam Ball 20kg
ZVO-SPSB-6875	ZVO Slam Ball 7kg	ZVO-SPSB-6883	ZVO Slam Ball 25kg
ZVO-SPSB-6876	ZVO Slam Ball 8kg	ZVO-SPSB-6884	ZVO Slam Ball 30kg
ZVO-SPSB-6877	ZVO Slam Ball 9kg		

Description		ZVO Slam Ball
Specifications		Made with premium hard-wearing PVC
Product Color		 Black / Yellow  Black / Grey
Increments		1kg increments from 2kg - 10kg, various weight increments from 12kg up to 35kg
Warranty		Limited 1 year warranty

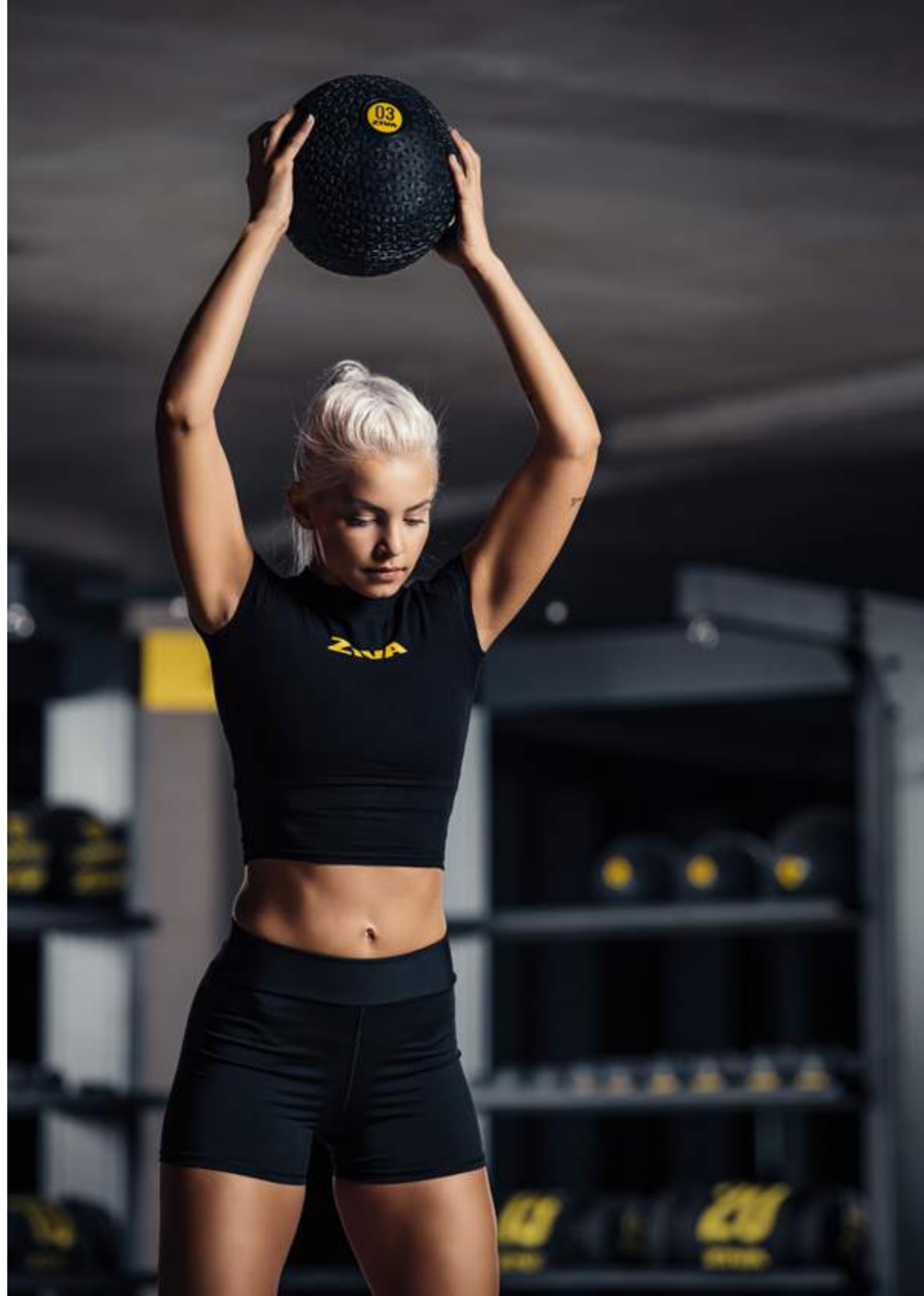

ST 5 MULTI-BALL TREE

The ZIVA® ST 5 Multi-Ball Tree is both a storage solution and a beautiful display for elite-level functional training equipment. Crafted with scratch-resistant black powder coating on tough round steel tubing and 5x shelves, the storage tree perfectly cradles all ball sizes and keeps surrounding spaces uncluttered, giving functional training areas a more premium, higher-end look and feel. The tree comes with the option of chrome-coated or black hardware, allowing for further enhanced gym aesthetics sure to entice visitors.



Order Code
ZST-MDRK-6008-BK

Item Description
ST 5 Multi-Ball Tree

Description		ST 5 Multi-Ball Tree
Specifications		Made with round steel tubing, welded frames, black or chromed coloured hardware
Product Color		Black powder-coated finish
Storage		Fits up to 5x medicine or slam balls
Dimensions		56cm x 47cm x 154cm - 13kg
Warranty		Limited 10 year warranty on frames and welding, 1 year on plastic parts

ST 10 MULTI-BALL TREE

The ZIVA® ST 10 Multi-Ball Tree is an expanded storage solution as well as a beautiful display for elite-level functional training equipment. Crafted with scratch-resistant black powder coating on tough round steel tubing and 10x shelves designed to perfectly cradles all ball sizes and keep surrounding spaces uncluttered, the storage tree gives functional training areas a more premium, higher-end look and feel, and comes with the option of chrome-coated or black hardware, allowing for further enhanced gym aesthetics sure to entice visitors.



Order Code
ZST-MDRK-6009-BK

Item Description
ST 10 Multi-Ball Tree

Description		ST 10 Multi-Ball Tree
Specifications		Made with round steel tubing, welded frames, black or chromed coloured hardware
Product Color		Black powder-coated finish
Storage		Fits up to 10x medicine or slam balls
Dimensions		101cm x 51cm x 163cm - 26kg
Warranty		Limited 10 year warranty on frames and welding, 1 year on plastic parts

ZEL ZVO PREMIUM WALL BALL

The ZVO Premium Wall Ball elevates this seemingly simple full-body strength, coordination, and intense cardio tool with premium textured synthetic leather outer casing and reinforced stitching. This elite-level equipment is guaranteed to push users' performance to its absolute limits, building explosive power alongside cardiovascular endurance and quick reflexes with a wide range of compound movements only possible with this tool.



Order Code	Item Description	Order Code	Item Description
ZVO-FTWB-6370	ZVO Premium Wall Ball 2kg	ZVO-FTWB-6375	ZVO Premium Wall Ball 7kg
ZVO-FTWB-6371	ZVO Premium Wall Ball 3kg	ZVO-FTWB-6376	ZVO Premium Wall Ball 8kg
ZVO-FTWB-6372	ZVO Premium Wall Ball 4kg	ZVO-FTWB-6377	ZVO Premium Wall Ball 9kg
ZVO-FTWB-6373	ZVO Premium Wall Ball 5kg	ZVO-FTWB-6378	ZVO Premium Wall Ball 10kg
ZVO-FTWB-6374	ZVO Premium Wall Ball 6kg	ZVO-FTWB-6379	ZVO Premium Wall Ball 12kg

Description		ZVO Premium Wall Ball
Specifications		Made with premium textured synthetic leather outer casing and hard-wearing stitching
Color Options	  Black / Yellow  Black / Grey	
Increments		1kg increments from 2kg - 10kg plus 12kg
Warranty		Limited 1 year warranty





ZEL ZVO PREMIUM POWER CORE BAG

The ZIVA® ZVO Premium Power Core Bag elevates this classic multipurpose functional training tool to elite heights with a rugged synthetic leather outer coating reinforced with thick composite skin; premium quality, high strength stitching and embroidery; and heavy-duty nylon straps and ergonomic handles. This highly flexible functional fitness tool, available in 2.5kg increments from 5-25kg as well as a 30kg size, includes air hole end caps for added safety and silencing and allows for a variety of compound and combined compound lifts favored in the elite training community.



Order Code	Item Description	Order Code	Item Description
ZVO-SPPB-6385	ZVO Premium Power Core Bag with Ergonomic Handle 5kg	ZVO-SPPB-6390	ZVO Premium Power Core Bag with Ergonomic Handle 17.5kg
ZVO-SPPB-6386	ZVO Premium Power Core Bag with Ergonomic Handle 7.5kg	ZVO-SPPB-6391	ZVO Premium Power Core Bag with Ergonomic Handle 20kg
ZVO-SPPB-6387	ZVO Premium Power Core Bag with Ergonomic Handle 10kg	ZVO-SPPB-6392	ZVO Premium Power Core Bag with Ergonomic Handle 22.5kg
ZVO-SPPB-6388	ZVO Premium Power Core Bag with Ergonomic Handle 12.5kg	ZVO-SPPB-6393	ZVO Premium Power Core Bag with Ergonomic Handle 25kg
ZVO-SPPB-6389	ZVO Premium Power Core Bag with Ergonomic Handle 15kg	ZVO-SPPB-6394	ZVO Premium Power Core Bag with Ergonomic Handle 30kg

Description		ZVO Premium Power Core Bag with Ergonomic Handle
Specifications		Made with premium textured synthetic leather outer casing and hard-wearing stitching and webbing
Color Options		Black / Yellow Black / Grey
Increments		2.5kg increments from 5kg - 2.5kg and 5kg increments from 25kg - 30kg
Warranty		Limited 1 year warranty

ST 10-PIECE FUNCTIONAL ACCESSORIES STORAGE RACK

The ZIVA® ST 10-Piece Functional Accessories Storage Rack is equal parts storage and display case. It features 10x cradles that are perfectly suited for storing various ball sizes and is made from sturdy 3mm thick steel tubing with a scratch- and wear-resistant black powder coat. With long-lasting assembly hardware available in black or chrome, the Functional Accessories Storage Rack is made to match with the overall ZIVA design language.



Order Code
ZST-FTRK-0210-BK

Item Description
ST 10-Piece Functional Accessories Storage Rack

Description		ST 10-Piece Functional Accessories Storage Rack
Specifications		Made with round steel tubing, welded frames, black or chrome colored hardware
Product Color		Black powder-coated finish
Storage		Fits up to 10x wall balls or power core bags
Dimensions		101cm x 51cm x 163cm - 26kg
Warranty		Limited 10 year warranty on frames and welding, 1 year on plastic parts

ST 5-PIECE FUNCTIONAL ACCESSORIES STORAGE RACK

The ZIVA® ST 5-Piece Functional Accessories Storage Rack is equal parts storage and display case. It features 5x cradles that are perfectly suited for storing various sizes of bag and is made from sturdy 3mm thick steel tubing with a scratch- and wear-resistant black powder coat. With long-lasting assembly hardware available in black or chrome, the Functional Accessories Storage Rack is made to match with the overall ZIVA design language.



Order Code
ZST-FTRK-0105-BK

Item Description
ST 5-Piece Functional Accessories Storage Rack

Description		ST 5-Piece Functional Accessories Storage Rack
Specifications		Made with round steel tubing, welded frames, black or chrome colored hardware
Product Color		Black powder-coated finish
Storage		Fits up to 5x wall balls or power core bags
Dimensions		56cm x 47cm x 154cm - 13kg
Warranty		Limited 10 year warranty on frames and welding, 1 year on plastic parts



10
ZIVA

10
ZIVA

ZIVA

ZEL SIGNATURE STEEL COMPETITION KETTLEBELLS BY STEVE COTTER

The ZIVA® Signature Steel Competition Kettlebells by Steve Cotter are the pinnacle of quality and design for this foundational functional fitness tool. Available in 2kg increments from 4-36kg with a crack- and scratch-resistant black powder coating and vibrant yellow, easy ID numbering, these kettlebells' full steel handle and bell elevate this traditional tool to the level of functional sculpture, something with which users will be proud to sculpt their bodies.

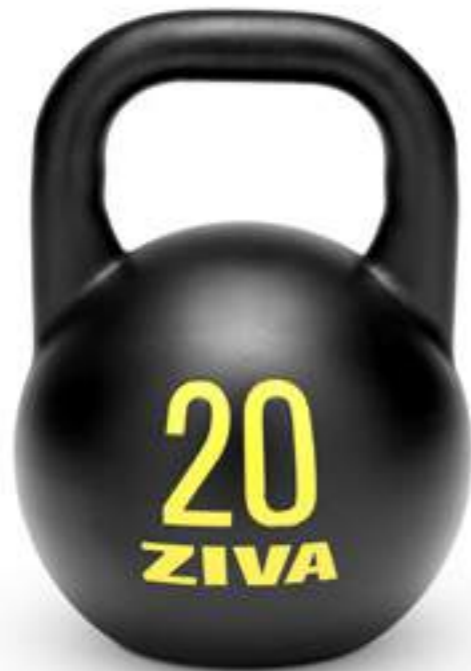

Order Code	Item Description	Order Code	Item Description
ZMT-CTKB-5659-BK	Signature Steel Competition Kettlebell 4kg	ZMT-CTKB-5627-BK	Signature Steel Competition Kettlebell 22kg
ZMT-CTKB-5660-BK	Signature Steel Competition Kettlebell 6kg	ZMT-CTKB-5628-BK	Signature Steel Competition Kettlebell 24kg
ZMT-CTKB-5620-BK	Signature Steel Competition Kettlebell 8kg	ZMT-CTKB-5629-BK	Signature Steel Competition Kettlebell 26kg
ZMT-CTKB-5621-BK	Signature Steel Competition Kettlebell 10kg	ZMT-CTKB-5630-BK	Signature Steel Competition Kettlebell 28kg
ZMT-CTKB-5622-BK	Signature Steel Competition Kettlebell 12kg	ZMT-CTKB-5631-BK	Signature Steel Competition Kettlebell 30kg
ZMT-CTKB-5623-BK	Signature Steel Competition Kettlebell 14kg	ZMT-CTKB-5633-BK	Signature Steel Competition Kettlebell 32kg
ZMT-CTKB-5624-BK	Signature Steel Competition Kettlebell 16kg	ZMT-CTKB-5634-BK	Signature Steel Competition Kettlebell 34kg
ZMT-CTKB-5625-BK	Signature Steel Competition Kettlebell 18kg	ZMT-CTKB-5637-BK	Signature Steel Competition Kettlebell 36kg
ZMT-CTKB-5626-BK	Signature Steel Competition Kettlebell 20kg		

Description		Signature Steel Competition Kettlebells by Steve Cotter
Coating		Steel bell and handle, with hard-wearing crack-resistant powder surface coating
Color Options		Black / Yellow
Increments		2kg increments from 4kg - 36kg
Handle		34mm steel handle with super textured powder coating to stop slippage during use
Warranty		Limited 5 year warranty

EX KETTLEBELL RACK

The ZIVA® EX Kettlebell Rack features a solid steel, heavy-duty frame with black panels and PVC-lined and -edged shelves for a protective storage space that doubles as a stunning display case. This Rack holds and shows off up to 10x kettlebells and comes with a scratch-, rust-, and wear-resistant black powder-coat finish as well as protective foot pads that keep floors pristine. This rack also comes with handsome chrome hardware for the option to bolt it in place, but with its 55kg heft, not including the kettlebells' weight, this is not a necessity.



Order Code	Item Description
ZEX-KB05-7003	EX Kettlebell Rack

Description		EX Kettlebell Rack
Specifications		Made with solid steel frame, welded, black panels and chrome colored hardware
Product Color		Metallic grey powder-coated finish with black panels
Storage		Fits up to 10 x kettle bells
Dimensions		125cm x 75cm x 55cm - 55kg
Warranty		Limited 10 year warranty on frames and welding, 1 year on plastic parts



45
ZIVA

40
ZIVA

35
ZIVA

30
ZIVA

25
ZIVA

20
ZIVA

ZEL SL VIRGIN RUBBER KETTLEBELLS

The ZIVA® SL Virgin Rubber Kettlebells, available in 2kg increments from 4-16kg, then 4kg increments from 20-40kg, use long-lasting wear-resistant virgin rubber coating that falls more quietly with less impact than its uncovered counterparts, so it won't damage surroundings even during intense use. It features an ultra-durable chrome grip less prone to dings and scratches than cast iron or plastic and serves a bold, iconic style that makes them gym centerpieces worthy of display.

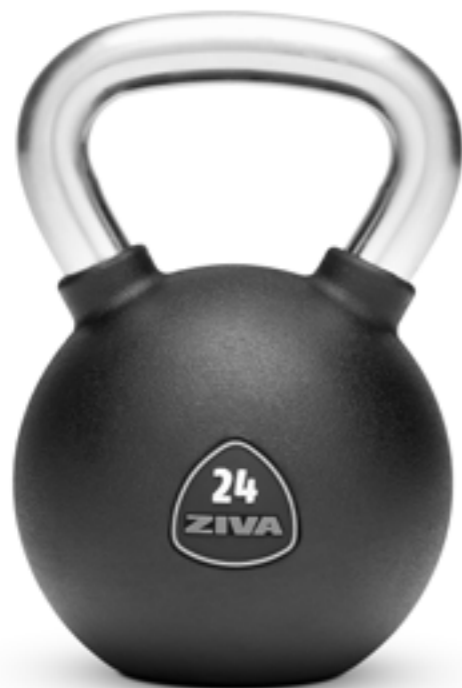

Order Code	Item Description	Order Code	Item Description
ZSL-RBKB-4320-GY	SL Virgin Rubber Kettlebell 4kg	ZSL-RBKB-4327-GY	SL Virgin Rubber Kettlebell 20kg
ZSL-RBKB-4321-GY	SL Virgin Rubber Kettlebell 6kg	ZSL-RBKB-4328-GY	SL Virgin Rubber Kettlebell 24kg
ZSL-RBKB-4322-GY	SL Virgin Rubber Kettlebell 8kg	ZSL-RBKB-4329-GY	SL Virgin Rubber Kettlebell 28kg
ZSL-RBKB-4323-GY	SL Virgin Rubber Kettlebell 10kg	ZSL-RBKB-4330-GY	SL Virgin Rubber Kettlebell 32kg
ZSL-RBKB-4324-GY	SL Virgin Rubber Kettlebell 12kg	ZSL-RBKB-4331-GY	SL Virgin Rubber Kettlebell 36kg
ZSL-RBKB-4325-GY	SL Virgin Rubber Kettlebell 14kg	ZSL-RBKB-4332-GY	SL Virgin Rubber Kettlebell 40kg
ZSL-RBKB-4326-GY	SL Virgin Rubber Kettlebell 16kg		

Description		SL Virgin Rubber Kettlebell
Coating		Solid precision casting, premium rubber surface coating
Color Options		Black with White and Grey
Increments		2kg increments from 4kg - 36kg
Handle		Hard chromed handle
Warranty		Limited 2 year warranty

ST KETTLEBELL RACK

The ZIVA® ST Kettlebell Rack is equal parts display case and storage piece. Designed to have a minimal footprint yet provide ample storage space, it fits up to 10x kettlebells on its thick steel, PVC-lined and -edged shelves. The Rack's solid steel construction features scratch-, rust-, and wear-resistant black powder coating and floor-protecting foot covers, and can be bolted down with chrome hardware if desired, but its 50kg heft is often secure enough.



Order Code	Item Description
ZST-KBRK-5395	ST Kettlebell Rack

Description		ST Kettlebell Rack
Specifications		Made with commercial grade 89mm steel tubing, welded base. Thick steel shelves with PVC mats and edging to protect the kettle bells. Chromed hardware
Product Color		Black powder-coated finish
Storage		Fits up to 10x kettle bells
Dimensions		111cm x 81.5cm x 66.5cm - 50kg
Warranty		Limited 10 year warranty on frames and welding, 1 year on plastic parts



ZVO URETHANE COMPETITION COLORED BUMPER DISCS



Screen printed numbers



Large hard chrome plated hubs
with internal diameter of 50.3mm



Beveled edges
for easy pickup



International standard
450mm outer diameter



Premium urethane coating



Competition colour coding

ZVO URETHANE COMPETITION COLORED BUMPER DISCS

ZIVA® ZVO Urethane Competition Colored Bumper Discs, precision casted with hard chrome-plated hubs, feature an ultra-long-lasting urethane coating that holds its vibrant IWF-standard colors for longer. Built to withstand the intensity of Olympic competition and with the durability needed for long-term use in commercial gyms, these bumper discs are not only available in the standard 5kg increments from 5-25kg, but also come in 0.5kg increments from 0.5-2.5kg.



Order Code	Item Description
ZVO-BDRB-3710	ZVO Rubber Competition Support Discs 2.5 kg
ZVO-BDPU-3702	ZVO Urethane Competition Colored Bumper Disc 5kg (80mm Hard Chrome Hub)
ZVO-BDPU-3703	ZVO Urethane Competition Colored BumperDisc 10kg (120mm Hard Chrome Hub)
ZVO-BDPU-3704	ZVO Urethane Competition Colored Bumper Disc 15kg (120mm Hard Chrome Hub)
ZVO-BDPU-3705	ZVO Urethane Competition Colored Bumper Disc 20kg (120mm Hard Chrome Hub)
ZVO-BDPU-3706	ZVO Urethane Competition Colored Bumper Disc 25kg (120mm Hard Chrome Hub)
ZVO-BDPU-3700	ZVO Urethane Fractional Disc Set (2x0.5kg, 2x1kg, 2x1.5kg, 2x2kg, 2x2.5kg)

Description		ZVO Urethane Competition Colored Bumper Disc
Coating		Ultra-premium urethane surface coating
Color Options		Black Green Yellow Blue Red
Increments		5kg increments
Warranty		Limited 5 year warranty

ZVO RUBBER COMPETITION COLORED TRAINING BUMPER DISCS

ZIVA® ZVO Rubber Competition Colored Training Bumper Discs, precision casted with premium hard chrome-plated hubs, feature an odorless, durable rubber coating that falls with less impact and noise for greater protection of surroundings. The bumper discs are made specially for training with the intensity necessary for Olympic competition and come in IWF-standard colors and weights with 5kg increments from 5-25kg, and 0.5kg increments from 0.5-2.5kg.



Order Code	Item Description
ZVO-BDPU-3701	ZVO Urethane Competition Support Disc 2.5 kg
ZVO-BDRB-3711	ZVO Rubber Competition Colored Training Bumper Disc 5kg (80mm Hard Chrome Hub)
ZVO-BDRB-3712	ZVO Rubber Competition Colored Training Bumper Disc 10kg (120mm Hard Chrome Hub)
ZVO-BDRB-3713	ZVO Rubber Competition Colored Training Bumper Disc 15kg (120mm Hard Chrome Hub)
ZVO-BDRB-3714	ZVO Rubber Competition Colored Training Bumper Disc 20kg (120mm Hard Chrome Hub)
ZVO-BDRB-3715	ZVO Rubber Competition Colored Training Bumper Disc 25kg (120mm Hard Chrome Hub)
ZVO-BDRB-3709	ZVO Rubber Fractional Disc Set (2x0.5kg, 2x1kg, 2x1.5kg, 2x2kg, 2x2.5kg)

Description		ZVO Rubber Competition Colored Training Bumper Disc
Coating		Premium solid virgin rubber
Color Options		Black Green Yellow Blue Red
Increments		5kg increments
Warranty		Limited 1 year warranty



ZIVA

15

15

ZIVA

34

33

22

26

25

24

23

10

12

XP COMPETITION COLORED RUBBER BUMPERS



Screen printed numbers



Stainless steel hubs with
internal diameter of 50.5mm



Beveled edges
for easy pickup



International standard
450mm outer diameter



Premium hard
wearing rubber







Competition colour coding

XP COMPETITION COLORED RUBBER BUMPERS

ZIVA® XP Competition Colored Rubber Bumpers feature an odorless, durable rubber coating that falls with less impact and noise for greater protection of surroundings. These bumper discs come in vibrant IWF-standard competition colors and are made tough to stand up to Olympic competition and the rigors of the high-traffic commercial gym environment. Available in 5kg increments from 5-25kg with beveled edges for easy moving.



Order Code	Item Description
ZXP-RBBP-7491	XP Competition Colored Rubber Bumper 5kg
ZXP-RBBP-7492	XP Competition Colored Rubber Bumper 10kg
ZXP-RBBP-7493	XP Competition Colored Rubber Bumper 15kg
ZXP-RBBP-7494	XP Competition Colored Rubber Bumper 20kg
ZXP-RBBP-7495	XP Competition Colored Rubber Bumper 25kg

Description	 XP Competition Colored Rubber Bumper
Coating	 Premium solid virgin rubber
Color Options	 <input type="checkbox"/> Black <input checked="" type="checkbox"/> Green <input checked="" type="checkbox"/> Yellow <input checked="" type="checkbox"/> Blue <input checked="" type="checkbox"/> Red
Increments	 5kg increments
Warranty	 Limited 1 year warranty

XP BUMPER STORAGE RACK

The ZIVA® XP Bumper Storage Rack, crafted from 3mm thick commercial-grade steel tube with a scratch-, wear-, and rust-resistant black powder-coated finish, keeps bumpers well organized for quick, easy use and a premium look. The Bumper Storage rack can store various sized plates from 5-25kg and comes with built-in wheels and a coated handle to keep heavy weights highly portable.



ZXP-RGRK-0902 XP Bumper Storage Rack

Description		XP Bumper Storage Rack
Specifications		Made with commercial-grade 3mm thick steel and built-in handle and wheels for easy portability
Product Color		Charcoal powder-coated finish
Dimensions		118cm x 40cm - 12kg
Warranty		Limited 10 year warranty on frames and welding, 1 year on plastic parts

ZVO PREMIUM OLYMPIC BARS



Fits standard Olympic discs



2.2m long, 20kg



Limited lifetime warranty



Premium hard coated chrome



Needle bearings and brass bushings for smooth rotation

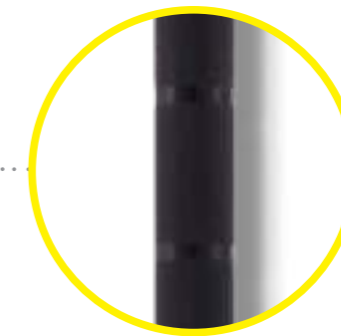







Weight lifting & power lifting grip indicators

ZVO PREMIUM OLYMPIC BARS

ZIVA® ZVO Premium Olympic Bars are the gold standard for weight lifting. Made to withstand the most rigorous commercial gym environments, these bars come in various lengths and weights to meet your training requirements; have been rigorously tested to the highest levels; and are available with chrome coating or black oxide finish. Fitted with needle bearings for smooth, even, easy rotation during lifts and etched with grip-assisting knurling, these Olympic bars are a testament to a gym's commitment to excellence.



Order Code	Item Description
ZVO-HCOB-2989	ZVO Technical 1.7m Bar - 25mm, 450kgs Tested 230K PSI, Brass Bushing, Needle Bearings, Weight: 10kgs
ZVO-HCOB-2991	ZVO Premium Olympic 2.01m Bar - 25mm, 700kgs Tested 230K PSI, Brass Bushing, Needle Bearings, Weight: 15kgs
ZVO-HCOB-2990	ZVO Premium Olympic 2.2m Bar - 28mm, 900kgs Tested 230K PSI, Brass Bushing, Needle Bearings, Weight: 20kgs
ZVO-HCOB-3025	2.2m Int'l Hard Chrome Bar, 380kg Test - 32 mm





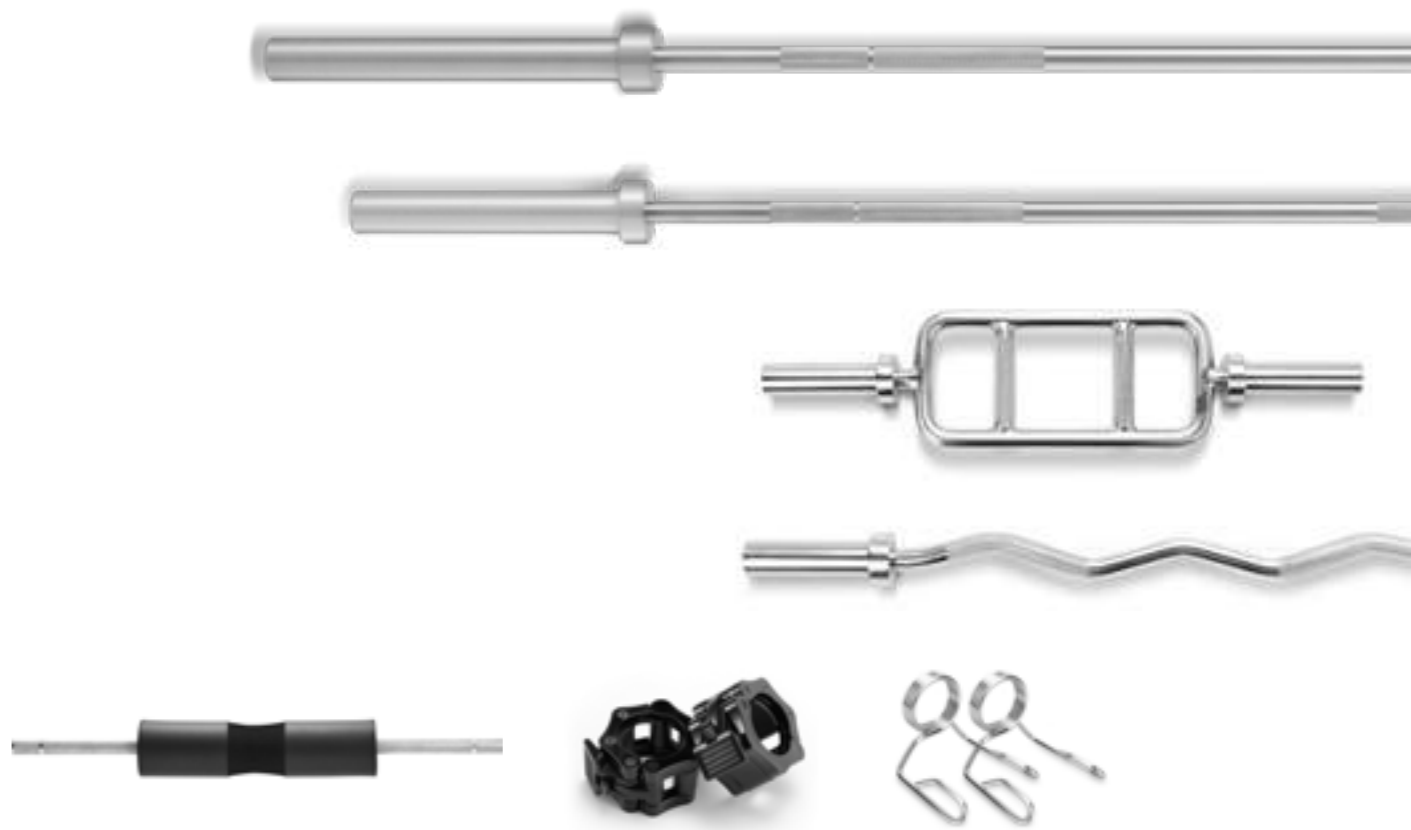

Description		ZVO Premium Olympic Bars
Coating		Premium hard chrome coated 50mm sleeves
Handle		Knurled grips with needle bearings for smooth and even rotation
Product Color		<input checked="" type="checkbox"/> Black oxide <input type="checkbox"/> Chrome
Weight Loading		Check the listings below for weight limits
Warranty		Limited lifetime warranty

ZVO OLYMPIC BARS

ZIVA® ZVO Olympic Bars come in a wide array of shapes, sizes, weights, and capacities, allowing gym owners to customize their free weight sections to meet the specific needs of their clientele. All bars feature a premium hard chrome coating and grip-assisting knurling, capped ends for decreased maintenance needs, and fit all Olympic-sized weight discs and clamp collars. Great bars are the building blocks from which great gyms are built, and ZIVA ZVO Olympic Bars deliver the quality and dependability commercial gyms around the world have come to rely on.



Order Code	Item Description
ZVO-LBHC-2953	ZVO Olympic 1.8m Bar - 30mm
ZVO-LBHC-2954	ZVO Olympic 1.5m Bar - 30mm
ZVO-HCOB-2965	ZVO Olympic 76cm Tricep Bar - 30mm
ZVO-HCOB-2966	ZVO Olympic 1.2m EZ Curl Bar - 30mm
BFH-NSRL-0001	Neck Support
ZXP-OBCC-0436-BK	ZVO Olympic Monster Clamp Collars
ZFT-OBST-0373	ZVO Olympic Spring Collar 100g

Description		ZVO Olympic Bars
Coating		Premium hard chrome coated 50mm sleeves
Handle		Knurled grips with bearings for smooth and even rotation
Product Color		<input checked="" type="checkbox"/> Black oxide <input type="checkbox"/> Chrome
Weight Loading		Check the listings below for weight limits
Warranty		Limited lifetime warranty

SPECIALTY OLYMPIC BARS

The ZIVA® Specialty Barbells, including the Multi-Grip Swiss Bar, Squat Safety Bar, Hex Trap Bar, and Open Hex Trap Bar, are all made with both beginners and pros in mind. Each of these heavy-duty bars come with a rust- and scratch-resistant coating and tough, Olympic-sized chrome sleeves with needle bearings for smooth rotation, but their true value lies in the greater safety and higher weights that they allow, especially for those with mobility challenges. The Multi-Grip Swiss Bar allow lifters to hit rarely reached angles while reducing stress on wrists, elbows, and shoulder joints. The Squat Safety Bar cushions necks and shoulders particularly for those with shoulder mobility issues. The Hex Trap Bar allows deadlifts with a more center-aligned weight and from a position safer for users' backs. And the Open Hex Trap Bar allows the same with greater freedom of movement. All of these bars are indispensable tools for seasoned lifters and those first learning to lift.

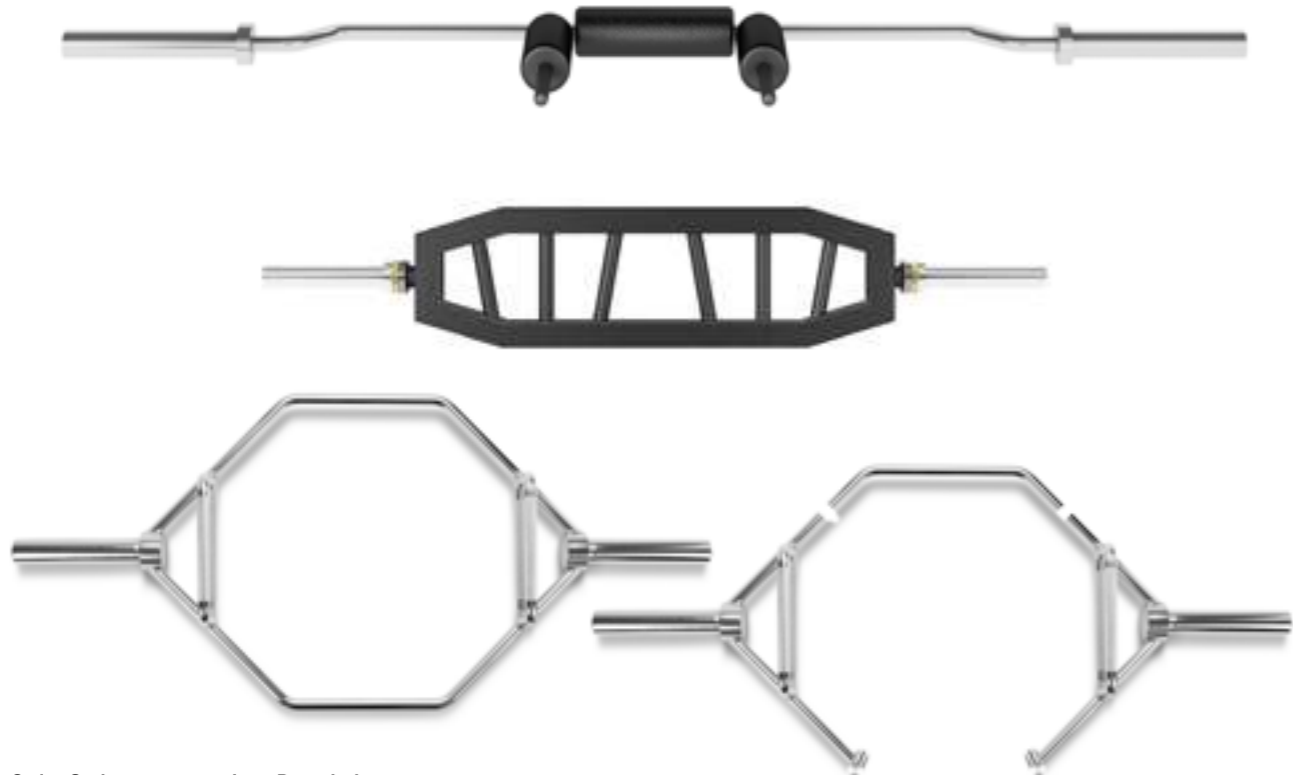

Order Code	Item Description
ZXP-SSBR-1503	Safety Squat Bar
ZVO-PBHC-2933	Multi-grip Swiss Bar
ZVO-PBHC-2936	ZVO Olympic 1.4m Hex Trap Bar - 25mm
ZVO-PBHC-1300	ZVO Olympic Open Hex Trap Bar

Description		Safety Squat Bar and Multi-grip Swiss Bar
Coating		ZXP-SSBR-1503 - Premium hard chrome bar and 50mm sleeves, synthetic leather coated pads ZVO-PBHC-2933 - Black oxide coated grip area with hard chromed sleeves ZVO-PBHC-2936/1300 - Premium urethane surface coating
Handle		ZXP-SSBR-1503 - Knurled grips with needle bearings for smooth and even rotation ZVO-PBHC-2933 - Knurled grips with multiple angles for muscle isolation ZVO-PBHC-2936/1300 - Knurled grips with bearings for smooth and even rotation
Color Options		<input checked="" type="checkbox"/> Chrome plus synthetic leather coated padding <input type="checkbox"/> Chrome
Weight Loading		ZXP-SSBR-1503 - 350kg ZVO-PBHC-2933 - 200kg ZVO-PBHC-2936/1300 - 150kg
Warranty		Limited lifetime warranty

OLYMPIC BAR STORAGE

The ZIVA® Performance Olympic Bar Storage, crafted with heavy-duty steel plate with a long-lasting, premium powder-coated finish, keeps up to 9x bars perfectly arranged in a vertical configuration that takes up minimum floor space for maximum efficiency, thus keeping even high-traffic commercial gyms well organized for a clutter free environment every visitor is bound to take note of.

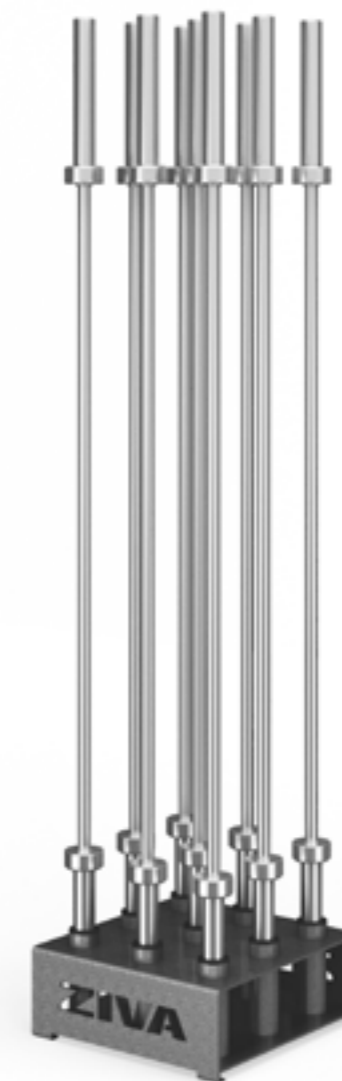

Order Code	Item Description
ZXP-OBSS-7217	Olympic Bar Storage Stand

Description		Olympic Bar Storage Stand
Specifications		Olympic Bar Rack made from steel plate
Coating		<input checked="" type="checkbox"/> Charcoal powder-coated finish
Storage		Fits up to 9 Olympic bars
Dimensions		46cm x 46cm x 19.5cm - 32kg
Warranty		Limited 10 year warranty on frames and welding, 1 year on plastic parts



Order Code	ZVO-HCOB-2990
Item Description	ZVO Premium Olympic 2.2m Bar
Weight	20kg
Capacity	900kg
Bar Diameter	28mm
Length	2.2m
Sleeve Length	50mm diameter; 445mm long



Order Code	ZVO-LBHC-2954
Item Description	ZVO Olympic Chrome Bar 1.5m
Weight	13kg
Capacity	150kg
Bar Diameter	30mm
Length	1.5m
Sleeve Length	50mm diameter; 270mm long



Order Code	ZVO-HCOB-2965
Item Description	ZVO Olympic Chrome Tricep Bar
Weight	14kg
Capacity	150kg
Bar Diameter	30mm
Length	0.895m
Sleeve Length	50mm diameter; 202mm long



Order Code	ZVO-HCOB-2966
Item Description	ZVO Olympic Chrome EZ Curl Bar
Weight	10kg
Capacity	150kg
Bar Diameter	30mm
Length	1.2m
Sleeve Length	50mm diameter; 202mm long



Order Code	ZVO-PBHC-2936
Item Description	ZVO Olympic Chrome Hex Trap Bar
Weight	20kg
Capacity	150kg
Bar Diameter	25mm
Length	1.4m
Sleeve Length	50mm diameter; 250mm long









ZXP HIP THRUSTER

ZIVA®'s ZXP Hip Thruster platform is the perfect station for glute building exercises and for improving on the weak points that usually keep users from achieving their best compound and functional fitness lifts. The ZXP is crafted from heavy-duty steel plate and tubing, and a slightly curved foam cushion with adjustable angle that helps guarantee both comfort and the optimal height for exercise execution. The platform also features 7x band pegs so bars can be loaded up with ZIVA Resistance Bands for extra intensity. PE wheels at the top of the ZXP make it easy to move around without compromising stability.



Order Code
ZXP-HPTR-2036

Item Description
ZXP Hip Thruster

Description		ZXP Hip Thruster
Coating		Premium hard wearing powder coating with synthetic leather coated padding
Color Options		 Black
Weight Loading		500kg
Warranty		Limited 5 year warranty on frames and welding; 1 year on plastic parts







ZEL SIGNATURE BATTLE ROPES

The ZIVA® Signature Battle Rope, designed in association with legendary strongman John Brookfield, is an elite functional fitness training tool with an undeniably premium look and feel. Available in a variety of lengths and weights, and woven from an ultra-long-lasting PP/nylon mix, the Signature Battle Rope features slick rubber handles that build users' grip strength and include patented wrist straps so they can keep going even after their grip fails. The Signature Series represents the very highest quality and the design to inspire new levels of intensity and passion.



Order Code	Item Description
ZMT-BTRP-5610	Signature Battle Rope (5cm x 15.24m) / (2.0" x 50') 16kg
ZMT-BTRP-5611	Signature Battle Rope (3.8cm x 10m) / (1.5" x 33') 10kg
ZMT-BTRP-5612	Signature Battle Rope (3.8cm x 15.24m) / (1.5" x 50') 12kg
ZMT-BTRP-5613	Signature Battle Rope (5.0cm x 10m) / (2.0" x 33') 10.6kg





Description	 Signature Battle Rope
Specifications	 PP and nylon intertwined rope with rubber handles, steel securing ring and patented wrist straps
Product Color	  Black with Yellow
Warranty	 Limited 1 year warranty

ZEL XP BATTLE ROPE

The ZIVA® XP Battle Rope, is the perfect harmony of high intensity interval training and complete upper body and core building exercise. Light enough for an exhaustive cardio workout and heavy enough to build shoulders, arms, back, and core strength, the Battle Rope is built tough. Woven from nylon with a protective nylon cover and easy-grip rubber handles with steel collars, its rugged durability is made for commercial gyms' rigors.



Order Code	Item Description
ZXP-BTRP-0913-BK	XP Battle Rope (3.8cm * 10m)

Description	 XP Battle Rope
Specifications	 Made from hard-wearing nylon & PP rope and with a nylon cover, rubber handles and a steel ring
Product Color	  Black
Warranty	 Limited 1 year warranty







SL TYRE X

ZIVA® SL TYRE X takes this increasingly popular functional strength training tool and enhances its usability, storability, and durability. Available in 10, 40, 60, and 80kg sizes, the TYRE X features a hard-wearing, reinforced PVC skin, reinforced PP/Nylon strap handles on each of its 10x sides and around its center, and a no-roll design that keeps it under control whether stored away or used as part of an intense workout. The SL TYRE X serves as a signal to functional fitness enthusiasts that a gym is at the forefront of the latest exercise movements.



Order Code	Item Description
ZSL-TYVR-4127	SL TYRE X 40kg
ZSL-TYVR-4128	SL TYRE X 60kg
ZSL-TYVR-4129	SL TYRE X 80kg
ZSL-TYVR-4139	SL TYRE X 10kg Pump







Description		SI TYRE X
Specifications		Long-lasting reinforced PVC cover and reinforced gripping handles with a internal PU foam structure to give added user protection
Product Color		 Black & Yellow
Warranty		Limited 1 year warranty

LANDING PADS

ZIVA® Landing Pads, made to catch Olympic bars and Olympic-sized weights, are must-have accessories for any gym where excessive noise or potential floor damage are a concern. Specially designed to cushion the fall of heavy weights dropped from overhead positions, these landing pads feature a PE foam inner core wrapped in tough, long-lasting reinforced PVC, and come with air release ports on the side to ensure greater safety and silence. These premium quality landing pads signal to any weight lifting enthusiast that this gym can surely meet their needs.



Order Code	Item Description
ZFT-OBLP-7843	Olympic Bar Landing Pads

Description		Olympic Bar Landing Pads
Specifications		PE foam inner core wrapped in tough, long-lasting reinforced PVC. Pads designed to absorb loaded Olympic bars dropped from height, air release ports and noise reduction for upper floor gyms
Product Color		 Black
Dimensions		80cm x 60cm x 21cm
Warranty		Limited 1 year warranty

ZEL SL SOFT PLYO BOX 3-IN-1 WITH PU FOAM

How do you get high-intensity high jumps with low risk and low impact? The SL Soft Plyo Box 3-in-1. This Plyo Box consists of a commercial-grade, high-durability anti-slip PVC skin that easily goes on and off of a PU foam core for easy cleaning. The box itself offers 3 different intensities. Turn it one way, and it's a tough 20" step platform. Turn it another, and it's a high-intensity jump workout tool. Give it one more turn to 30" and it's a workout that builds speed, explosivity, and power. Any way you turn it, it's a functional fitness mainstay.



Order Code
ZSL-SFPY-4013

Item Description
SL Soft Plyo Box 3-in-1 with PU Foam (51cm x 61cm x 75cm)

Description		SL Soft Plyo Box 3-in-1 with PU Foam
Specifications		Made with a Solid PU foam inner core, with PVC outer coating
Product Color		Black with white
Warranty		Limited 1 year warranty

ZEL ZVO GLUTE PLYO BOX

While usable as a regular plyo box, the ZIVA® ZVO Glute Plyo Box is specially designed to emphasize glute and calf activation in a way that's impossible with the average, flat-topped box. The Glute Plyo Box's sloping surface, covered in a high-durability PVC coat, forces users' feet, ankles, and legs into the optimal positions to most accurately target tough to hit body parts so trainers can ensure better results in the areas that matter most to users.



Order Code
ZMT-GLPY-5671

Item Description
ZVO Glute Plyo Box

Description		ZVO Glute Plyo Box
Specifications		Inner core is made with a PE Foam core and PU foam outer shell. The outside is made from hard-wearing PVC shell with webbing handles
Product Color		Black with yellow
Warranty		Limited 1 year warranty



ZIVA

ZIVA

75 cm 30"

51 cm 20"

61 cm 24"

61 cm 24"

ZEL ZVO DUAL SURFACE PLYO BOX 3-PIECE SET

The ZVO Dual Surface Plyo Box 3-Piece Set delivers hard-wearing versatility that stacks and stores with ease. Each of the 3 differently sized boxes - 15cm, 30cm, and 45cm - feature a firm side that acts as a steady landing platform at any height and a soft side that challenges users' ankle, knee, and hip stabilizers for incomparable functional fitness workouts. Stable even when stacked thanks to sturdy velcro straps, these Plyo Boxes come wrapped in a tough PVC skin that gives them a long life even with heavy use in high-traffic commercial gyms.



Order Code
ZFT-PYST-0738

Item Description
ZVO Dual Surface Plyo Box 3 Piece Set - 15, 30, and 45cm (6", 12", and 18" inches) New Velcro Strap

Description		ZVO Dual Surface Plyo Box 3 Piece Set
Specifications		Made with a solid PE foam inner core, with solid PU foam edging, with hard wearing PVC outer coating
Product Color		Black, Grey and Yellow
Warranty		Limited 1 year warranty

ZEL ZVO DUAL SURFACE PLYO BOX 4-PIECE SET

The ZVO Dual Surface Plyo Box 4-Piece Set delivers hard-wearing versatility that stacks and stores to the greatest heights. Each of the 4 differently sized boxes - 15cm, 30cm, 45cm, and 60cm - feature a firm side that acts as a steady landing platform at any height and a soft side that challenges users' ankle, knee, and hip stabilizers for incomparable functional fitness workouts. Sturdy velcro straps keep them stable no matter how high they are stacked and a tough PVC skin gives them a long life even with heavy use in high-traffic commercial gyms.



Order Code
ZFT-PYST-0739

Item Description
ZVO Dual Surface Plyo Box 4 Piece set - 15, 30, 45 and 60cm (6", 12", 18" and 24" inches) New Velcro Strap

Description		ZVO Dual Surface Plyo Box 4 Piece Set
Specifications		Made with a solid PE foam inner core, with solid PU foam edging, with hard-wearing PVC outer coating
Product Color		Black, Grey and Yellow
Warranty		Limited 1 year warranty

ZEL XP POWER SLED

The ZIVA® XP Power Sled with included Harness is a full-body functional fitness mainstay that delivers strength and cardio gains in a single, rugged package. The Sled is crafted from 3mm thick steel with a scratch- and wear-resistant charcoal powder-coat finish and itself weighs in at a hefty 39kg but can be stacked with as much weight as you need. It is built with both full vertical handles that allow for pushing at a variety of heights, and a lowdown crossbar perfect for anchoring the harness or driving at a super-low angle. However this versatile power-building tool is used, it adds an unquestionable air of intensity and gravitas to any functional fitness area.



Order Code
ZXP-PWSD-7231

Item Description
XP Power Sled

Description		XP Power Sled
Specifications		Made with commercial-grade steel tubing and plate steel and high tensile hardware. Includes harness
Product Color		Charcoal powder-coated finish
Dimensions		101cm x 61cm - 39kg
Warranty		Limited 10 year warranty on frames and welding, 1 year on plastic parts



XP FARMERS WALK HANDLES

ZIVA® XP Farmer's Walk Handles take a traditional functional fitness exercise for training grip, core, and traps, and incorporates the heavy-duty ability to add up to 250kg. Made from 3mm thick steel and coated with a scratch- and wear-resistant black powder finish, the Handles help round out a functional fitness area's power-building equipment and tells visitors that this is a gym that prides itself on offering the latest and greatest fitness tools.



Order Code
ZXP-RGRK-0916

Item Description
XP Farmers Walk Handles

Description		XP Farmers Walk Handles
Specifications		32mm grip diameter and 3mm thick steel
Product Color		Charcoal powder-coated finish
Dimensions		Length 180cm - 24kg per pair
Warranty		Limited 10 year warranty on frames and welding, 1 year on plastic parts

XP STORAGE BOX

The ZIVA® XP Storage Box, built completely from steel with a scratch- and wear-resistant black powder-coating to withstand the rigors of high-traffic commercial gyms, makes it easy to keep all gym areas clutter-free so a premium look and feel is constantly maintained. Large enough to fit all of an area's accessory equipment, the Storage Box comes with 4x 360° wheels so moving whatever is needed wherever it's needed is always simple and fast.



Order Code
ZXP-SBXW-1198

Item Description
XP Storage Box

Description		XP Storage Box
Specifications		A lockable all-steel storage box on wheels for storing all of those small accessories
Product Color		Black powder-coated finish
Dimensions		60cm x 50cm x 85cm - 60kg
Warranty		Limited 10 year warranty on frames and welding, 1 year on plastic parts







ZEL ZVO ANTI-BURST CORE-FIT BALLS

With the right tools, training becomes a part of everyday life, and our Anti-Burst Core Fit Ball makes it easy. Add it to any weight-focused workout to challenge users and increase recruitment of stabilizer muscles; or make it the centerpiece of core workouts for maximum muscle-building across the entire abdominal wall, easily and efficiently targeting the abs, obliques, and erectors. Designed with a non-slip, easy to grip surface and made with BPA-free PVC, the ZVO Anti-Burst Core Fit Ball comes in different sizes for different body types, but all are tested up to 400kg so workout sessions stays safe no matter how intense.



Order Code	Item Description
ZVO-ABCB-9291	ZVO 55 cm Anti-Burst Core-Fit Ball
ZVO-ABCB-9270	ZVO 65 cm Anti-Burst Core-Fit Ball





Description		ZVO Anti-Burst Core-Fit Ball
Specifications		Made with heavy-duty and durable PVC
Color Options		 Black / Yellow
Warranty		Limited 1 year warranty

TPE DELUXE YOGA MAT

The ZIVA® TPE Deluxe Yoga Mat is the premiere choice for floor-based exercise functionality. Available in 10 or 14mm thicknesses, the Deluxe Yoga Mat gives users a comfy cushion while preventing slippage of hands and feet with a wavy textured surface and keeping the mat secured with a high traction textured bottom. A cutting-edge closed-cell formulation prevents absorption of liquid and eyelets allow for easy, out of the way storage.



Order Code	Item Description
ZSL-TDYM-0250	TPE Deluxe Yoga Mat 125cm x 61cm x 14mm
ZSL-TDYM-0251	TPE Deluxe Yoga Mat 165cm x 61cm x 10mm
ZVO-MTRK-0200	Studio Mat Rack





Description		TPE Deluxe Yoga Mat
Specifications		Latex-free TPE foam, patterned surface provides secure traction, closed cell construction prevents absorption of liquids, eyelets for easy storage and 10mm or 14mm thickness
Product Color		 Black / Grey
Warranty		Limited 1 year warranty

STUDIO NBR MAT

The 15mm thick ZIVA® Studio NBR Mat is a well-cushioned cloud of comfort that provides a soft, airy cradle for users during any floor-based exercises. Perfect for use on the often textured floors of functional fitness areas, these mats feature easy to clean hygienic surfaces and eyelets for easy, out of the way storage. Available in stylish black, the Studio NBR Mat uses the same ZIVA design language that make all our products aesthetic wonders.



Order Code	Item Description
ZSL-NPSM-0204	Studio NBR Mat 165cm x 61cm x 15mm

Description		Studio NBR Mat
Specifications		Thick cushioned NBR (Studio Mat) with a soft airy feel, easy to clean hygienic surface and 15mm thickness <i>Not suitable for polished surfaces</i>
Product Color		 Black
Warranty		Limited 1 year warranty



ZVO BALANCE PAD

The ZIVA® ZVO Balance Pad is built for functional fitness. The Balance Pad, crafted from long-lasting expanded TPE with a textured top to prevent slippage, offers an accessible entry point to training tough to hit but essential stabilizer muscles.



Order Code
ZFT-FPST-0190

Item Description
ZVO Balance Pad

Description		ZVO Balance Pad
Specifications		ZFT-FPST-0190 - Made with expanded TPE
Product Color		Black
Warranty		Limited 1 year warranty

PRO FT STEP

The ZIVA® Pro FT Step takes the tried and true aerobic step and elevates it with a hard-wearing, non-slip PP landing pad and aesthetically advanced ZIVA design language that gives its surroundings an immediate premium look and feel. The Pro FT Step is a must-have in any functional fitness area and makes delivery of group classes simple and scalable, as its multi-height stackability allows users to set their own pace with minimal instruction needed.



Order Code
ZFT-FTSP-0593

Item Description
Pro FT Step

Description		Pro FT Step
Specifications		Hard-wearing PP casing, non-slip landing pad, multi-height and stackable
Product Color		Black / Yellow Black / Grey
Warranty		Limited 1 year warranty





ZVO BALANCE BALL

The ZIVA® ZVO Balance Ball, crafted with long-lasting, durable PVC for the ball and tough PP edging on bottom, provides a premium, commercial-grade traditional functional training tool that enables low-impact, stress-reducing exercises to strengthen core and stabilizer muscles so users' maintain a healthy balance throughout their musculoskeletal system. In grey and black, it brings an understated aesthetic made to match ZIVA design language.



Order Code
ZXP-BUBL-0564

Item Description
ZVO Balance Ball

Description		ZVO Balance Ball
Specifications		Made with hard-wearing PVC bladder and PP edging
Product Color		 Black / Grey
Warranty		Limited 1 year warranty





ZIVA

65
ZIVA

55
ZIVA

ZIVA

ZIVA

ZIVA

A full-page photograph of a muscular man with a beard and short dark hair, shirtless and wearing black shorts. He is leaning on a black pull-up bar with both hands, looking directly at the camera. The background is a gym setting with a dark metal rack. To the left, there are several colorful resistance bands (red, green, yellow, black) hanging from the rack. The rack has white numbers (34, 33, 32, 31, 29, 28, 27, 26, 25, 24, 22, 21, 20, 19, 18) indicating height levels. The lighting is dramatic, highlighting the man's physique.

RACKS & RIGS

The greatest gyms help clients enjoy intense, heavy workouts in less time with racks and storage that use great design and great construction to deliver safety and stability while keeping everything they need close at hand.



Customizable functional training with a premium look and feel. That's the underlying design concept for the EX Series. Every EX training station is made to fit a range of accessories that enable suspension training, ball workouts, boxing and more. And while all the products in our Commercial Line are made to withstand the rigors of high-traffic commercial gym environments, because the EX Series is made to support the twisting, turning, explosive action of functional fitness workouts, it features enhanced stability with ultra-durable hardware that locks it into the floor.

XP

Gyms come in a vast variety of shapes and sizes. XP racks and rigs are modular marvels that can be mixed and matched to fit any gym, whatever its shape or size. Every piece in the XP Series features commercial grade steel plate and tubing, and zinc-coated hardware, and thus can easily be fixed together to create facility-spanning structures. Each piece in the Series can also be customized with any of the 16x XP Rig Attachments for greater storage and training options to perfectly meet the unique needs of any gym.

XP2

The XP2 Series offers an ideal solution to the question of whether to dedicate an area to storage or to training equipment. The answer? Both. These racks and rigs seamlessly combine an array of storage options with a range of training equipment in packages that maximize efficient use and utilization of valuable floor space. Capable of handling both the heavy-duty weights of barbells movements and the rapid twists and turns of suspension trainers, resistance bands, and battle ropes while holding all manner of equipment, the XP2 Series lets gyms have it all.



ZEL ZEP EX TRAINING CORNER

The ZIVA® EX Training Corner takes gyms' often underutilized corner spaces and makes them into customizable storage and training hubs. The Training Corner's structure is formed from thick steel plate with a scratch-, corrosion-, and rust-resistant black powder coating, and features grey steel tube rungs made to fit all EX Training Accessories so gym owners can tailor it to their facility's needs. The rungs double as anchors for suspension trainers and stretches.

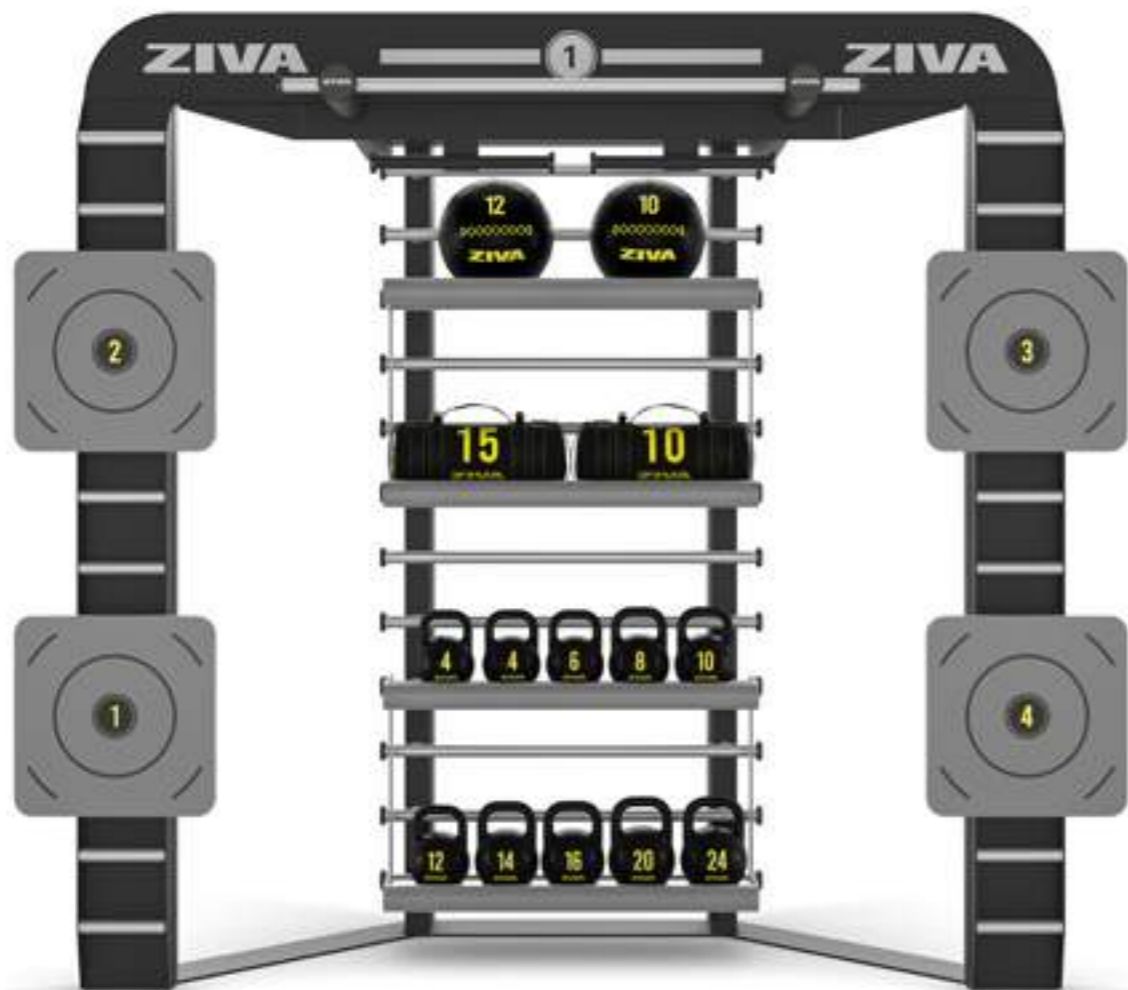

Order Code
ZEX-XCRN-0051

Item Description
EX Training Corner 2.43m H

Description		EX Training Corner
Specifications		Made with full commercial plate steel and fittings. Built to withstand the rigors of large member gyms, built to last and look amazing. Must be bolted to the floor.
Product Color		Black powder-coated finish with grey detailing
Dimensions		276cm x 150cm x 243cm - 560kg
Warranty		Limited 10 year warranty on frames and welding; 1 year on plastic parts

ZEL ZEP EX TRAINING TOWER BRIDGE

The ZIVA® EX Training Tower Bridge, made from thick steel plate, 3mm steel tube rungs, and covered in a scratch-, corrosion-, and rust-resistant powder coat finish, is a customizable training hub. The rungs, located at every conceivable angle, fit any and all EX Training Accessories so it can be made to cater to any gym's unique clientele. The tough rungs also serve as anchors for suspension trainers, resistance bands, bodyweight work, and for stretching.



Order Code
ZFS-TBDG-7997

Item Description
EX Tower Bridge 3m - 2.43m H

Description		EX Tower Bridge
Specifications		Made with full commercial plate steel and fittings. Built to withstand the rigors of large member gyms, built to last and look amazing. Must be bolted to the floor.
Product Color		Black powder-coated finish with grey detailing
Dimensions		387cm x 86cm x 243cm - 791kg
Warranty		Limited 10 year warranty on frames and welding; 1 year on plastic parts







ZEL ZEP EX TRAINING TOWER

The ZIVA® EX Training Tower features thick 6mm steel plate set with 3mm steel tube rungs that fit all EX Training Accessories, making it a freestanding, customizable training hub. This piece is specially designed for the attachment of 4 boxing bag supports, making it a beacon for those who seek specialized cardio workouts, personal training, and limited group classes. As with all EX pieces, it also serves as an anchor for suspension training, stretching, and more.



Order Code
ZFS-XTTR-9898

Item Description
EX Training Tower (Includes Boxing Bag Support Arms x 4)

Description		EX Training Tower Tower
Specifications		Made with full commercial plate steel and fittings. Built to withstand the rigors of large member gyms, built to last and look amazing. Must be bolted to the floor.
Product Color		 Black powder-coated finish with grey detailing
Dimensions		213cm x 213cm x 275cm - 888kg
Warranty		Limited 10 year warranty on frames and welding; 1 year on plastic parts





EX TRAINING ACCESSORIES

The ZIVA® EX line of training rigs, with their thick steel tube ladder rungs, is made to be immediately and constantly customizable with EX Training Accessories. These Accessories fit easily on the rigs' rungs and can be quickly taken off and replaced as needed. Accessories include EX Fixed Parallels for bodyweight exercises; EX Wall Ball Targets to add challenge to ball throwing movements; EX Universal Shelving for storage; the EX Torso Trainer for fixed point pivoting barbell movements; ZIVA 12 oz. Boxing Gloves; and the ZIVA Microfiber Leather Punching Bag.



Order Code	Item Description	Order Code	Item Description
ZEX-XACS-9945	1 EX Fixed Parallels	ZEX-XBND-9887	5 EX Training Bands
ZEX-XACS-9946	2 EX Wall Ball Target	ZEX-XBND-9888	6 EX Training Functional Bands
ZEX-XACS-9948	3 EX Universal Shelf	ZEX-XBND-9889	7 EX Training Ladder
ZEX-XACS-9947	4 EX Torso Trainer		







EX HALF RACK WITH STORAGE

The ZIVA® EX Half Rack with Storage, crafted from thick steel plate and tubing with reinforced welds and a scratch-, corrosion-, and rust-resistant black powder coating, delivers not only a heavy-duty rack made to withstand the rigors of high-traffic commercial gyms, but also offers a convenient space-saving solution that allows for more intense workouts thanks to faster loading and unloading. Just as the squats, presses, and deadlifts this rack makes safe and possible are the foundation of any great workout, the EX Half Rack with Storage is the foundation of any great gym.



Order Code
ZEX-RKHF-6888

Item Description
EX Half Rack with Storage

Description		EX Half Rack with Storage
Specifications		Made with round steel tubing and thick plate steel, welded frames, black or chrome colored hardware
Product Color		<input checked="" type="checkbox"/> Charcoal powder-coated finish
Dimensions		186cm x 215cm x 238cm - 315kg
Warranty		Limited 10 year warranty on frames and welding; 1 year on plastic parts



XP POWER RACK WITH STORAGE

The ZIVA® XP Power Rack with Storage is the heaviest of the heavy-duty. Made with scratch-, rust-, and corrosion-resistant powder coated thick steel tubing with laser-cut holes and numbering, a steel tube pull-up bar, and 8x chromed storage posts, this Power Rack serves as the most durable, safest and stables arena for heavy-lifting, and can be customized to create a totally tailored training platform with ZIVA XP Rig Attachments. This unique design lets gym owners increase storage and add training tools to craft a gym centerpiece that does everything they need it to do.



Order Code
ZXP-RKFL-7208

Item Description
XP Power Rack with Storage

Description		XP Power Rack with Storage
Specifications		Laser-cut holes (50mm spacing) and numbering system, hard-wearing powder-coated finish 3mm thick steel 75 x 75mm frame, 24mm zinc-coated hardware, eight chromed bumper plate storage posts, one pair of J-Cups, additional holes at base for band or accessories attachment, must be bolted to the floor, two inside safety spotter arms (UMHW plastic protection coating) and single pull-up bar & cross beam
Color Options		<input checked="" type="checkbox"/> Charcoal roof / Charcoal frame
Dimensions		127cm x 201cm x 237cm - 224kg
Warranty		Limited 10 year warranty on frames and welding; 1 year on plastic parts

XP HALF RACK WITH STORAGE

The ZIVA® XP Half Rack with Storage, made from thick steel tubing with a steel tube pull-up cross-bar and scratch-, rust-, and corrosion-resistant powder coating, comes with 8x chromed storage posts, 2x J-Cups, and 2x Safety Arms, but this Half Rack is more than a rack. Its laser-cut holes are made to fit the entire range of XP Rig Attachments, so it can serve not only as a heavy barbell-based training hub, but also as a versatile storage solution.



Order Code
ZXP-RKHF-7206

Item Description
XP Half Rack with Storage

Description		XP Half Rack with Storage
Specifications		Laser-cut holes (50mm spacing) and numbering system, hard-wearing powder-coated finish 3mm thick steel 75 x 75mm frame, 24mm zinc-coated hardware, eight chromed bumper plate storage posts, one pair of J-Cups, additional holes at base for band or accessories attachment, two safety spotter arms and single pull-up bar & cross beam
Color Options		<input checked="" type="checkbox"/> Charcoal roof / Charcoal frame
Dimensions		127cm x 160cm x 237cm - 178kg
Warranty		Limited 10 year warranty on frames and welding; 1 year on plastic parts



ZIVA

ZIVA
25
ZIVA

ZIVA
25
ZIVA

ZIVA
20
ZIVA

ZIVA
10
ZIVA

ZIVA
15
ZIVA

ZIVA
5
ZIVA







ZIVA
25
ZIVA

XP 14' FREESTANDING SPACE SAVER RACK

The ZIVA® XP 14' Freestanding Space Saving Rack is a multi-person training hub with integrated storage that helps maximize efficient use of space. The Space Saver Rack features 2x half racks with 2x pairs of J-Cups, 2x pairs of safety arms, 2x pairs of dual-height flying pull-up bars plus one long bar in the middle, 8x chromed storage posts, 3x storage shelves, and near-infinite customization. The Rack's precision laser-cut holes are specially designed for the addition of XP Rig Attachments for expanded storage and training options to perfectly meet any gym's unique needs.



Order Code	Item Description
ZXP-SSRG-0899	XP 14' Freestanding Space Saver Rack
ZXP-SSPL-1510	Space Saver Rack Safety Plate 1.8m

Description		XP 14' Freestanding Space Saver Rack
Specifications		Made with 75mm x 75mm x 3mm commercial grade steel, and high tensile bolts. 2 pairs of J-Cups, 2 pairs of safety arms, 2 flying pull-up bars, 2 kettlebell/dumbbell storage shelves, 1 bumper storage shelf, 8 bumper pegs
Product Color		 Charcoal roof / Charcoal frame
Dimensions		483cm x 142cm x 243cm - 385kg
Warranty		Limited 10 year warranty on frames and welding; 1 year on plastic parts







The Rack can also be combined with the Space Saver Rack Safety Plates.

XP 24' FREESTANDING SPACE SAVING RACK

The ZIVA® XP 24' Freestanding Space Saving Rack is a multi-person training hub with integrated storage that further maximizes efficient use of space. The Space Saver Rack features 3x half racks with all the necessary J-Cups and safety arms, 3x pull-up bars, 8x chromed storage posts, 6x storage shelves, and precision laser-cut holes designed for the addition of XP Rig Attachments. The customization this allows makes the Rack perfect for high-traffic gyms and opens the door to exciting, high-value possibilities for small-to-medium group personal training classes.



Order Code	Item Description
ZXP-SSRG-0919	XP 24' Freestanding Space Saving Rack
ZXP-SSPL-1510	Space Saver Rack Safety Plate 1.8m

Description		XP 24' Freestanding Space Saving Rack
Specifications		Made with 75mm x 75mm x 3mm commercial grade steel, and high tensile bolts. 3 pairs of J-Cups, 3 pairs of safety arms, 3 flying pull-up bars, 4 kettlebell/dumbbell storage shelves, 2 bumper storage shelf, 8 bumper pegs
Product Color		 Charcoal roof / Charcoal frame
Dimensions		784cm x 142cm x 243cm - 621kg
Warranty		Limited 10 year warranty on frames and welding; 1 year on plastic parts

The Rack can also be combined with the Space Saver Rack Safety Plates.



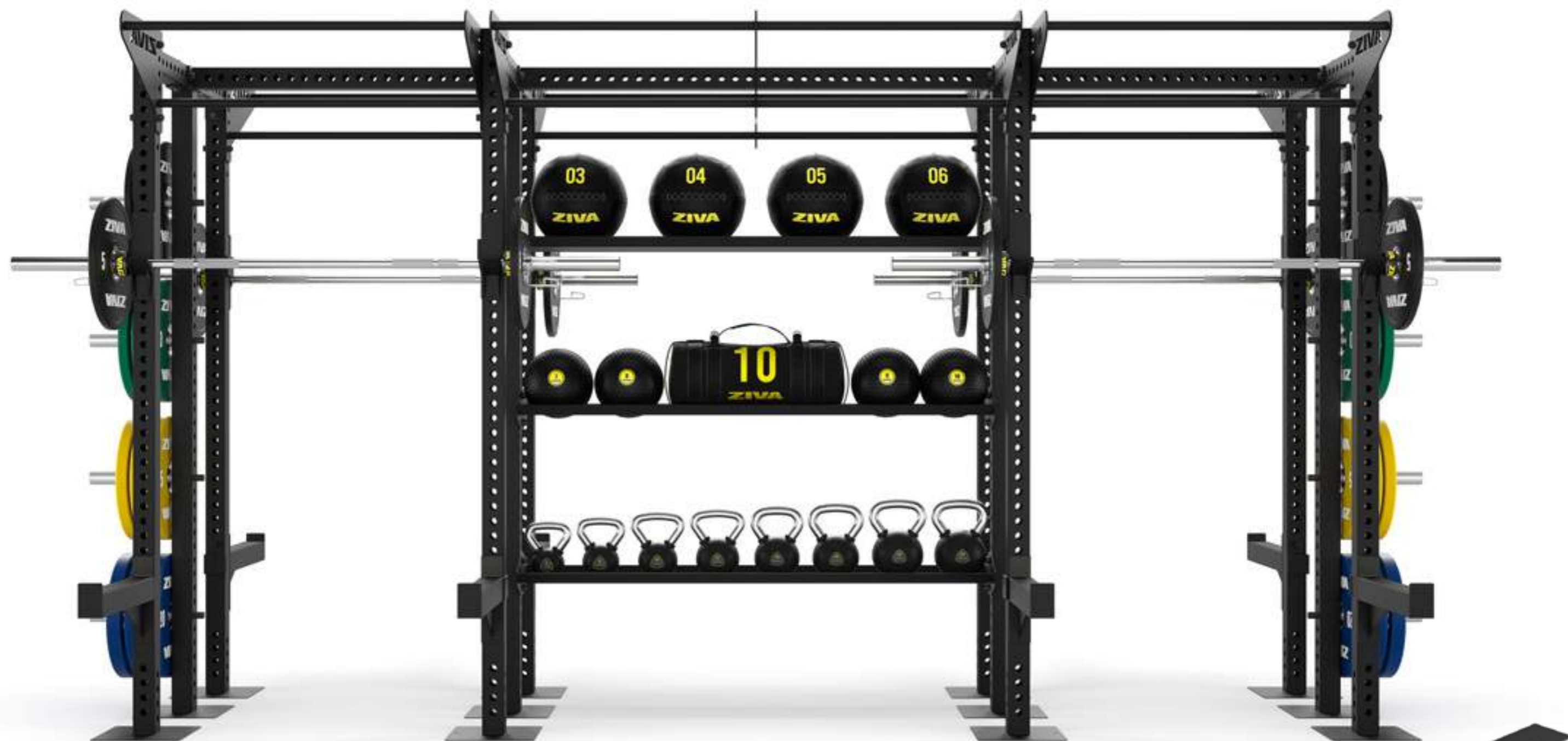

XP 14' DOUBLE-SIDED FREESTANDING SPACE SAVING RIG

The ZIVA® XP 14' Double-Sided Freestanding Space Saving Rig is a multi-person training hub with integrated storage that maximizes efficient use of space and opens the door to exciting, high-value possibilities for small-to-medium group personal training classes. The Space Saving Rig features 4x half racks with all the necessary J-Cups and safety arms, 4x pairs of dual-height flying pull-up bars plus 2x long dual-height bars in the middle, 3x storage shelves, and near-infinite customization. Precision laser-cut holes across the entire Rig allow for the addition of XP Rig Attachments for expanded storage and training options to perfectly meet any high-traffic gym's unique needs.

The Rack can also be combined Double Sided Space Saving Rack Safety Plates.

Order Code	Item Description
ZXP-SSRG-0792	XP 14' Double-Sided Freestanding Space Saving Rig
ZXP-SSPL-1511	Double Sided Space Saving Rig Safety Plate 2m

Description		XP 14' Double-Sided Freestanding Space Saving Rig
Specifications		Made with 75mm x 75mm x 3mm commercial grade steel, and high tensile bolts. 4 pairs of J-Cups, 4 pairs of safety arms, 6 flying pull-up bars, 2 kettlebell/dumbbell storage shelves, 1 bumper storage shelf
Product Color		Charcoal roof / Charcoal frame
Dimensions		483cm x 227cm x 243cm - 655kg
Warranty		Limited 10 year warranty on frames and welding; 1 year on plastic parts





XP 24' DOUBLE-SIDED FREESTANDING SPACE SAVING RIG

For high-traffic gyms, especially those that aim to provide high-value, medium-sized personal training or CrossFit classes, the ZIVA® XP 24' Double-Sided Freestanding Space Saving Rig is the ultimate multi-person training and storage hub. 6x complete half racks, 6x pairs of dual-height flying pull-up bars plus 4x long dual-height bars, 6x storage shelves, 8x chromed storage posts, and precision laser-cut holes where XP Rig Attachments can be added for complete customization make this a hub of intense activity that elevates the atmosphere of any gym.

The Rack can also be combined Double Sided Space Saving Rack Safety Plates.

Order Code

ZXP-SSRG-0780

ZXP-SSPL-1511

Item Description

XP 24' Double-Sided Freestanding Space Saving Rig

Double Sided Space Saving Rig Safety Plate 2m

Description		XP 24' Double-Sided Freestanding Space Saving Rig
Specifications		Made with 75mm x 75mm x 3mm commercial grade steel, and high tensile bolts. 6 pairs of J-Cups, 6 pairs of safety arms, 10 flying pull-up bars, 4 kettlebell/dumbbell storage shelves, 2 bumper storage shelf
Product Color		Charcoal roof / Charcoal frame
Dimensions		781cm x 227cm x 243cm - 1061kg
Warranty		Limited 10 year warranty on frames and welding; 1 year on plastic parts

SELF-SUPPORTED MODULAR RIGS

ZIVA® Self-Supported Modular Rigs are both expandable and customizable. Crafted from thick steel tubing with a scratch-, corrosion-, and rust-resistant powder coat, each section bolts into the floor with zinc-coated hardware and includes dual-height flying pull-up bars and a pair of J-Cups, and can be attached or detached piece-by-piece depending on a space's overall layout and design. The Rigs' laser-cut holes are made to fit all XP Rig Attachments so the structure can be customized for tailor-made storage and training hubs that perfectly meet a facility's unique needs.



Order Code	Item Description
ZXP-SSRG-0999-CCCC	9' Self Supported Modular Rig (4' Station)
ZXP-SSRG-0921-CCCC	9' Self Supported Modular Rig (10' Station)
ZXP-SSRG-0922-CCCC	9' High Self-Supported Modular Rig (14' Station)
ZXP-SSRG-0923-CCCC	9' Self Supported Modular Rig (20' Station)
ZXP-SSRG-0924-CCCC	9' High Self-Supported Modular Rig (24' Station)
ZXP-RGSP-0962	Rigs Safety Plate

Description		9' High Self-Supported Modular Rigs
Specifications		Laser-cut with powder-coated finish, 3mm thick steel 75 x 75mm frame, 24mm zinc-coated hardware, 4' section x 6' section, includes one pair of J-Cups for each 4' wide rigs, includes flying dual-height pull-up bars for each rigs section
Product Color		Charcoal roof / Charcoal frame
Dimensions		ZXP-SSRG-0999-CCCC - 122cm x 183cm x 274cm - 145kg ZXP-SSRG-0921-CCCC - 305cm x 183cm x 274cm - 195kg ZXP-SSRG-0922-CCCC - 427cm x 183cm x 274cm - 300kg ZXP-SSRG-0923-CCCC - 610cm x 183cm x 274cm - 389kg ZXP-SSRG-0924-CCCC - 732cm x 183cm x 274cm - 468kg
Warranty		Limited 10 year warranty on frames and welding; 1 year on plastic parts

The rack can also be combined with Rigs Safety Plates.

WALL-MOUNTED MODULAR RIGS

ZIVA® Wall-Mounted Modular Rigs are expandable and customizable, and zinc-coated hardware to bolt directly into walls to help maximize efficient use of space. Crafted from thick steel tubing with a scratch-, corrosion-, and rust-resistant powder coat, each section includes dual-height flying pull-up bars and a pair of J-Cups, and can be attached or detached piece-by-piece depending on a space's overall layout and design. The Rigs' laser-cut holes are made to fit all XP Rig Attachments for tailor-made storage and training hubs made to match any gym's unique needs.



Order Code	Item Description
ZXP-WMRG-0999-CCCC	9' Wall-Mounted Modular Rig (4' Station)
ZXP-WMRG-0926-CCCC	9' Wall-Mounted Modular Rig (10' Station)
ZXP-WMRG-0927-CCCC	9' High Wall-Mounted Modular Rig (14' Station)
ZXP-WMRG-0928-CCCC	9' Wall-Mounted Modular Rig (20' Station)
ZXP-WMRG-0929-CCCC	9' High Wall-Mounted Modular Rig (24' Station)

Description		9' High Wall-Mounted Modular Rigs
Specifications		Laser-cut with powder-coated finish, 3mm thick steel 75 x 75mm frame, 24mm zinc-coated hardware, 4' section x 6' section, includes one pair of J-Cups for each 4' wide rigs, includes flying dual-height pull-up bars for each rigs section
Product Color		Charcoal roof / Charcoal frame
Dimensions		ZXP-WMRG-0999-CCCC - 122cm x 122cm x 274cm- 90kg ZXP-WMRG-0926-CCCC - 305cm x 122cm x 274cm- 107kg ZXP-WMRG-0927-CCCC - 427cm x 122cm x 274cm- 165kg ZXP-WMRG-0928-CCCC - 610cm x 122cm x 274cm- 213kg ZXP-WMRG-0929-CCCC - 732cm x 122cm x 274cm - 256kg
Warranty		Limited 10 year warranty on frames and welding; 1 year on plastic parts

XP SPACE SAVING WALL-MOUNTED RIGS

XP Space Saving Wall-Mounted Rigs are expandable and customizable, and come with zinc-coated hardware to bolt directly into walls to help maximize efficient use of space. Crafted from thick steel tubing with a scratch-, corrosion-, and rust-resistant black powder coat, each section includes dual-height flying pull-up bars and a pair of J-Cups, and can be attached or detached piece-by-piece depending on a space's overall layout and design. The Rigs' laser-cut holes are made to fit all XP Rig Attachments so gym owners can create tailor-made storage and training hubs made to match their unique needs.



ZXP-WMRG-5313



ZXP-WMRG-2031



ZXP-WMRG-2032









ZXP-WMRG-2033



ZXP-WMRG-2034

Order Code	Item Description
ZXP-WMRG-5313	XP Space Saving 4' Wall Mounted Rig
ZXP-WMRG-2031	XP Space Saving 10' Wall Mounted Rig
ZXP-WMRG-2032	XP Space Saving 14' Wall Mounted Rig
ZXP-WMRG-2033	XP Space Saving 20' Wall Mounted Rig
ZXP-WMRG-2034	XP Space Saving 24' Wall Mounted Rig

Description		XP Space Saving Wall Mounted Rigs
Specifications		Laser-cut with powder-coated finish, 3mm thick steel 75 x 75mm frame, 24mm zinc-coated hardware, 4' section x 6' section, includes one pair of J-Cups for each 4' wide rigs, includes flying dual-height pull-up bars for each rigs section
Color Options		 Charcoal roof / Charcoal frame
Dimensions		ZXP-WMRG-5313 - 122cm x 117cm x 271cm - 78kg ZXP-WMRG-2031 - 327cm x 117cm x 271cm - 122kg ZXP-WMRG-2032 - 446cm x 117cm x 271cm - 172kg ZXP-WMRG-2033 - 625cm x 117cm x 271cm - 218kg ZXP-WMRG-2034 - 744cm x 117cm x 271cm - 268kg
Warranty		Limited 10 year warranty on frames and welding; 1 year on plastic parts





XP RIG ATTACHMENTS

ZIVA® XP Rigs are made to be customizable, featuring laser-cut holes specially designed to fit XP Rig Attachments. These Attachments turn XP Rigs into storage for balls, bells, and bumpers; add functional fitness functionality with a range of anchors and attachments; and exponentially increase the value and versatility of a gym's rigs and space.



Order Code	Item Description	Order Code	Item Description
ZXP-RGAT-0986-CC	1 XP Ball Target Attachment	ZXP-RGAT-0938	7 XP Core-Fit Ball Storage Shelf 72'
ZXP-RGAT-0991-CC	2 XP Pull-Up Ball Attachment	ZPX-RGAT-0971	8 XP Kettlebell/Dumbbell Storage Shelf 72'
ZXP-RGAT-0987-CC	3 XP D-Handle Attachment	ZXP-RGAT-0994-CC	9 XP Safety Arms Attachment
ZXP-RGAT-0993-CC	4 XP J-Cup Attachment	ZXP-RGAT-0979	10 XP Battle Rope Storage Attachment
ZXP-RGAT-0973-CC	5 XP Sandwich J-Cup Attachment	ZXP-RGAT-0101	11 XP Landmine Attachment
ZXP-RGAT-0937	6 XP Core-Fit Ball Storage Shelf 42'	ZXP-RGAT-0995-CC	12 XP Chrome Plate Storage Peg Attachment

Warranty		Limited 1 year warranty
-----------------	--	-------------------------

Multigrip cross bars, flying pull up bars and dip station attachment available on request.

XP RIG ATTACHMENTS

ZIVA® XP Rigs are made to be customizable, featuring laser-cut holes specially designed to fit XP Rig Attachments. These Attachments turn XP Rigs into storage for balls, bells, and bumpers; add functional fitness functionality with a range of anchors and attachments; and exponentially increase the value and versatility of a gym's rigs and space.

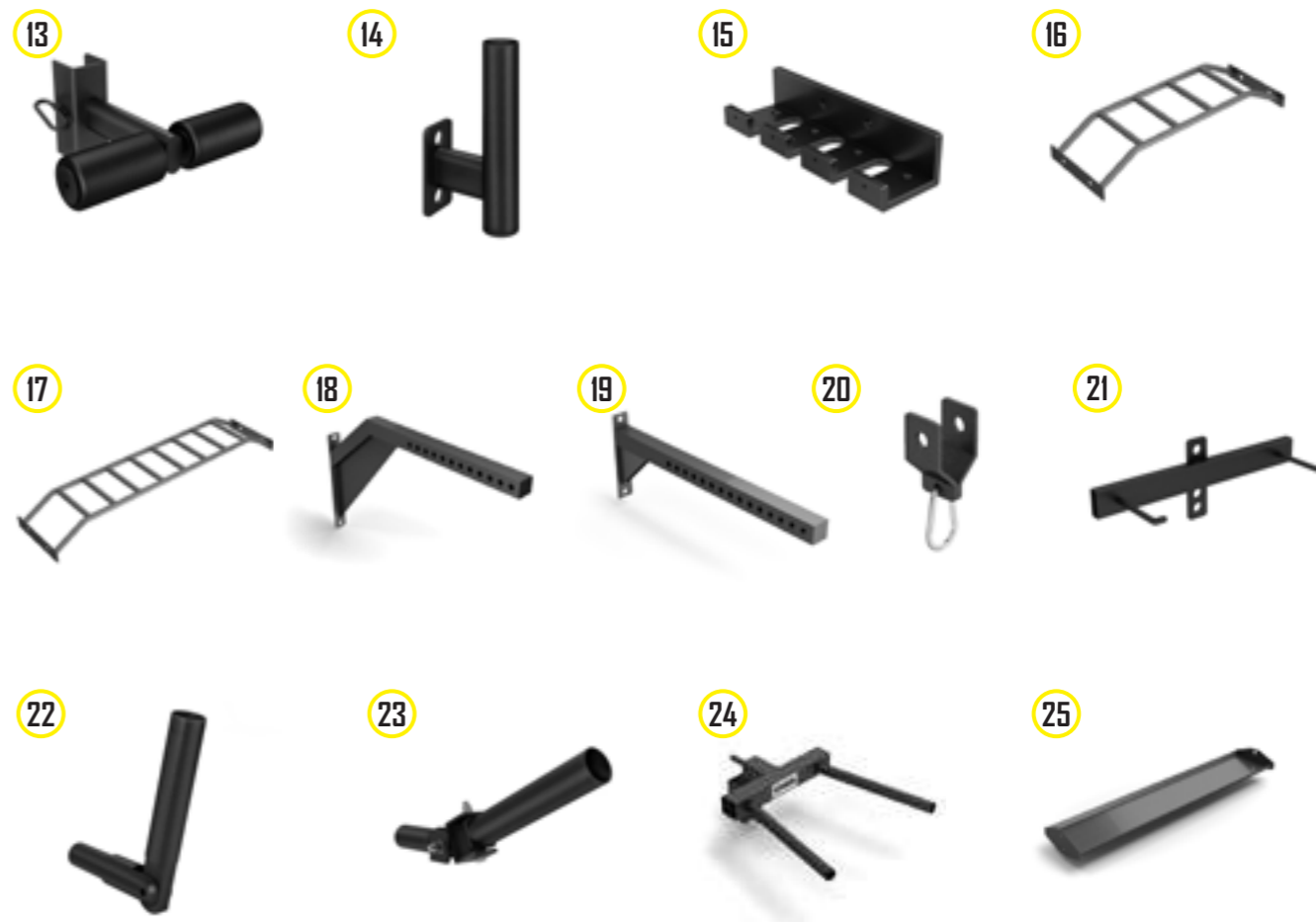

Order Code	Item Description	Order Code	Item Description
ZXP-RGAT-0020	13 XP Removable Thigh Pad Attachment	ZXP-RGAT-0999	19 XP Flat Arm Cantilever Accessory Extension Attachment
ZXP-RGAT-0996	14 XP Frame Mount Single Bar Storage Attachment	ZXP-RGAT-0988	20 XP Frame Mount Accessory Shackle w/Carabiner Attachment
ZXP-RGAT-0957	15 XP Roof Mount Olympic Bar Storage (3 bars)	ZXP-RGAT-0967	21 XP Mat Storage Attachment
ZXP-RGAT-0997-CC	16 XP 4' Multigrip Crossbar	ZXP-RGAT-0977	22 XP Pivot Plate Landmine Attachment
ZXP-RGAT-0998-CC	17 XP 6' Multigrip Crossbar	ZXP-RGAT-0694	23 XP Steel Power Pivot Plate Landmine Attachment
ZXP-RGAT-0960	18 XP Angled Arm Cantilever Accessory Extension Attachment	ZXP-RGAT-0983-CC	24 XP Dip Station Attachment
		ZXP-RGAT-0971	25 XP Kettlebell/Dumbbell Storage Shelf (6 Foot)

Warranty		Limited 1 year warranty
-----------------	--	-------------------------

Multigrip cross bars, flying pull up bars and dip station attachment available on request.

ZEL ZEP XP 4-SHELF MULTI-FUNCTIONAL STORAGE RACK

The ZIVA® XP 4-Shelf Multi-Functional Storage Rack is equal parts practical storage solution and beautiful display. Crafted with ultra-durable, thick steel plate, the Storage Rack shows off balls, bells, and discs of all variety and uses the same ZIVA design language, giving all the pieces a unified look that lends gyms a more premium feel.



Order Code
ZXP-MFSR-7219

Item Description
XP 4-Shelf Multi-Functional Storage Rack

Description		XP 4-Shelf Multi-Functional Storage Rack
Specifications		3 mm thick steel, multi-storage rack stores: hex dumbbells, kettlebells, wall balls, med balls, and bumper discs
Product Color		Black & grey powder-coated finish
Dimensions		187cm x 86cm x 182cm - 128kg
Warranty		Limited 10 year warranty on frames and welding; 1 year on plastic parts

ZEL ZEP XP 4-TIER STORAGE RACK

The ZIVA® XP 4-Tier Storage Rack is a storage and display piece that features swivelling wheels for quick, easy movement around the gym. Crafted from thick steel tubing & plate steel with a scratch-, rust-, and corrosion-resistant powder coat, this 4-tier Rack fits all manner of bells, balls, and functional fitness equipment, making it ideal for personal trainers who need to move rapidly from one workout and one client to the next.



Order Code
ZXP-TBSR-6775
ZXP-TBSR-4071

Item Description
XP 4-Tier Storage Rack
XP 4-Tier Storage Rack + XP Training Toolkit Set

Description		XP 4-Tier Storage Rack
Specifications		Horizontal style frame, 3mm thick oval tube steel and wheeled base for easy portability
Product Color		Black powder-coated finish
Dimensions		166cm x 84cm x 166cm - 110kg
Warranty		Limited 10 year warranty on frames and welding; 1 year on plastic parts







XP2 CORNER

The ZIVA® XP2 Corner transforms often difficult to utilize corner spaces into training and storage hubs. This innovative piece, crafted with commercial-grade steel tubing, thick plate steel, and reinforced welding across the entire frame, includes stretching and pull-up bars, a multitude of anchor points for suspension and resistance band training equipment, 8x PVC-lined shelves, hooks for holding compatible yoga mats, and comes with a range of options that allow for extensive expansion, both for storage and for exercise. Alone, the XP2 Corner is an optimal solution for maximal space utilization. Combined with additional XP2 Accessories, it can turn previously forgotten corners into the backbone of great gyms.



Order Code
ZXP-XCRN-0285

Item Description
XP2 Corner 8' (243cm)

Description		XP2 Corner
Specifications		Made with commercial-grade 3mm tubing, laser-cut and welded. Utilizing thick plate steel for the shelving. Commercial quality.
Product Color		<input checked="" type="checkbox"/> Black powder-coated finish
Dimensions		227cm x 227cm x 243cm - 450kg
Warranty		Limited 10 year warranty on frames and welding; 1 year on plastic parts





2
LINA

6
LINA

20
LINA

24
LINA

XP2 FLOOR-MOUNTED FUNCTIONAL RACKS

The ZIVA® XP2 Floor-Mounted Functional Rack takes the traditional squat bay used for heavy barbell movements and combines it with storage and customizability. Crafted using commercial-grade thick steel tube and plate, the storage portion of this rack includes 4x shelves made to fit dumbbells, kettlebells, and functional training equipment, and 1x shelf specially made for large wall or core fit balls. The squat bay, built with the same ultra-durable commercial-grade materials, comes with a pair of J-Cups and safety arms, and can be added onto with the entire range of XP2 Accessories for additional storage and/or functional fitness pieces. Pull-up bars span the entire structure and an included punching bag and suspension point further make the XP2 Floor-Mounted Functional Rack a gym centerpiece designed to meet a variety of needs.







ZXP-SSRG-0317



ZXP-SSRG-0318

Order Code	Item Description
ZXP-SSRG-0316	XP2 Floor-Mounted Squat + 6' Rack
ZXP-SSRG-0317	XP2 Floor-Mounted Storage Rack 6'
ZXP-SSRG-0318	XP2 Floor-Mounted Squat Unit

Note: You must purchase the ZXP-SSRG-0316 as the base unit, then add on ZXP-SSRG-0317 or ZXP-SSRG-0318 as needed

Description	 XP2 Floor-Mounted Functional Racks
Specifications	 Made with commercial-grade 3mm tubing, laser-cut and welded. Utilizing thick plate steel for the shelving. Full commercial quality. Includes 1 pair of J-Cups & safety arms. Boxing bag and suspension points included
Product Color	 Black powder-coated finish
Warranty	 Limited 10 year warranty on frames and welding; 1 year on plastic parts

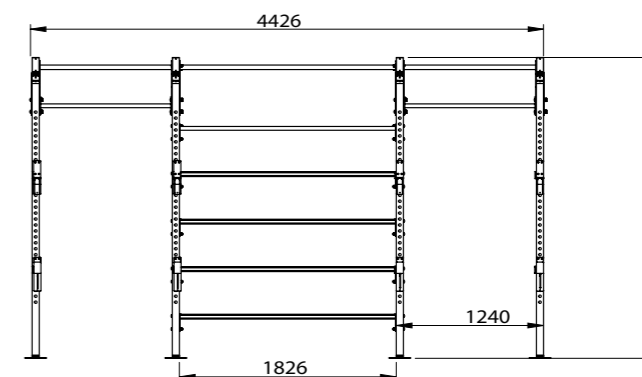

Order Code	Item Description
ZXP-SSRG-0688	XP2 Floor-Mounted 1 x Functional 6' Rack + 2 x Squat Bays includes 4 x J-Cups & Safety Arms. Length: 4.3m

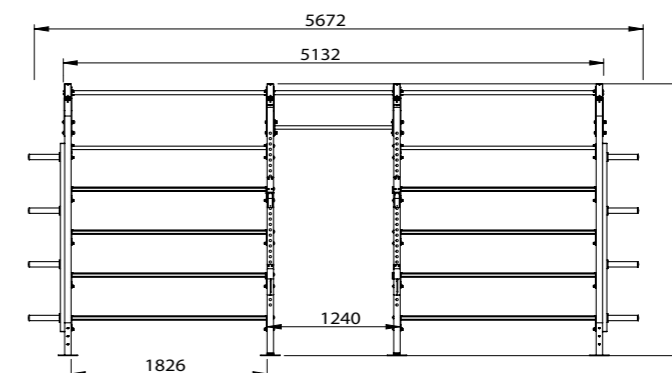

Order Code	Item Description
ZXP-SSRG-0788	XP2 Floor-Mounted 2 x Functional Racks + 1 x Squat Bays includes 2 x J-Cups & Safety Arms. Length: 5.2m

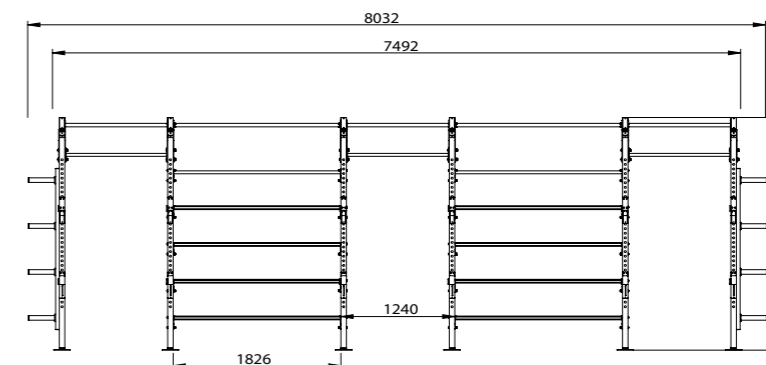

Order Code	Item Description
ZXP-SSRG-0787	XP Floor-Mounted 2 x Functional Racks + 3 x Squat Bays includes 6 x J-Cups & Safety Arms. Length: 7.5m

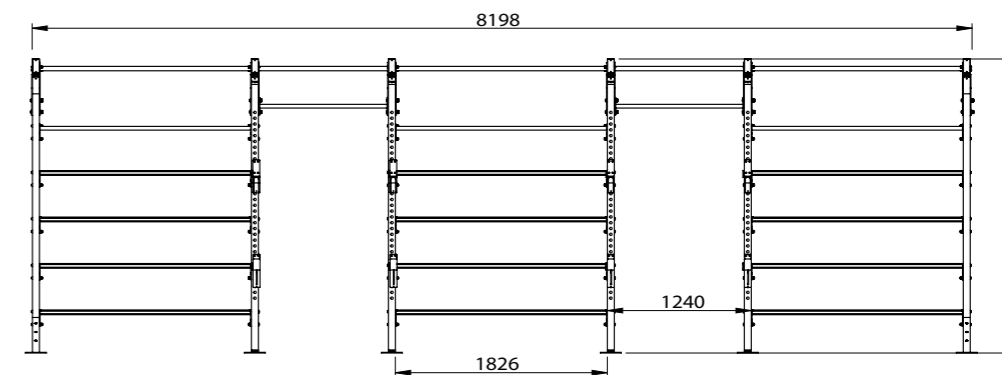

Order Code	Item Description
ZXP-SSRG-0397	XP Floor-Mounted 3 x Functional Racks + 2 x Squat Bays includes 4 x J-Cups & Safety Arms. Length: 8.2m

XP2 ACCESSORIES

All ZIVA® XP2 pieces are designed to accommodate these steel plate XP2 Accessories with corrosion-, rust-, and scratch-resistant black powder coating. The Accessories range from additional storage for barbells, bands, and dumbbells, to additional anchor points for suspension trainers, resistance bands, and battle ropes, and equipment that enables an even broader range of functional training exercises. These customization options mean that each XP2 can be tailor-made to suit the unique needs of any given high-traffic gym.



Compatible with the XP2 Corner

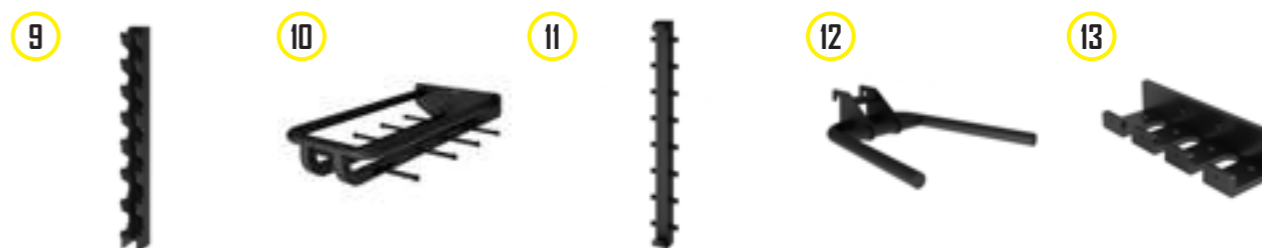

Order Code	Item Description	Order Code	Item Description
ZXP-RGAT-4746	1 XP2 Resistance Band Anchor	ZXP-RGAT-4785	8 XP2 J-Cups
ZXP-RGAT-4748	2 XP2 Ball Target	ZXP-RGAT-4747	9 XP2 Vertical Dumbbell Storage - 5 Pair
ZXP-RGAT-4750	3 XP2 Double Play - Bar & Plate Storage	ZXP-RGAT-4749	10 XP2 Ball & Hanging Storage Extension
ZXP-RGAT-4753	4 XP2 Battle Rope Anchor	ZXP-RGAT-4751	11 XP2 Attachment Anchor
ZXP-RGAT-4754	5 XP2 Hanging Storage Hook	ZXP-RGAT-4752	12 XP2 Dip Attachment
ZXP-RGAT-4755	6 XP2 Horizontal Mount Ground Rotational Trainer	ZXP-RGAT-9806	13 XP2 Roof-Mounted Olympic Bar Storage (3 Bars)
ZXP-RGAT-4784	7 XP2 Safety Arms		

ZXP-RGAT-4752 cannot be used without ZXP-RGAT-4751



STUDIO

Every piece in the Studio Line is made to facilitate as wide a range of functional exercises as possible but have been designed with slim profiles and small footprints to allow for maximally efficient use of floorspace. This emphasis on function is also matched with equal attention to form. The Studio Line uses an understated and unified aesthetic language so mixed and matched pieces maintain a clean, cohesive appearance that gives their gyms an elite-level look and feel.

PERFORMANCE HEXAGON DUMBBELL SET

ZIVA® Performance Hexagon RPU Dumbbells offer a sleek, eye-catching alternative to the shabby steel-grey iron chunks of yesteryear, featuring textured, hard-wearing, long-lasting RPU coatings over the dumbbells' heads; corrosion-, wear-, and rust-resistant chrome-coated handles; modern aesthetics in a no-roll design; and always reliable, world-class ZIVA quality.



Order Code	Item Description	Order Code	Item Description
ZFT-DBUX-5140-BKGY	Performance Hexagon RPU Dumbbell Set 2.5kg	ZFT-DBUX-5148-BKGY	Performance Hexagon RPU Dumbbell Set 22.5kg
ZFT-DBUX-5141-BKGY	Performance Hexagon RPU Dumbbell Set 5kg	ZFT-DBUX-5149-BKGY	Performance Hexagon RPU Dumbbell Set 25kg
ZFT-DBUX-5142-BKGY	Performance Hexagon RPU Dumbbell Set 7.5kg	ZFT-DBUX-5150-BKGY	Performance Hexagon RPU Dumbbell Set 27.5kg
ZFT-DBUX-5143-BKGY	Performance Hexagon RPU Dumbbell Set 10kg	ZFT-DBUX-5151-BKGY	Performance Hexagon RPU Dumbbell Set 30kg
ZFT-DBUX-5144-BKGY	Performance Hexagon RPU Dumbbell Set 12.5kg	ZFT-DBUX-5204-BKGY	Performance Hexagon RPU Dumbbell Set 32.5kg
ZFT-DBUX-5145-BKGY	Performance Hexagon RPU Dumbbell Set 15kg	ZFT-DBUX-5205-BKGY	Performance Hexagon RPU Dumbbell Set 35kg
ZFT-DBUX-5146-BKGY	Performance Hexagon RPU Dumbbell Set 17.5kg	ZFT-DBUX-5206-BKGY	Performance Hexagon RPU Dumbbell Set 37.5kg
ZFT-DBUX-5147-BKGY	Performance Hexagon RPU Dumbbell Set 20kg	ZFT-DBUX-5207-BKGY	Performance Hexagon RPU Dumbbell Set 40kg

Description		Performance Hexagon Dumbbell
Specifications		Unique patented design made with premium rubberized polyurethane outer casing with steel heads and chrome handles
Handle		Premium chrome handle
Color Options		Black with grey and white
Increments		2.5kg increments
Warranty		Limited 2 year warranty

PERFORMANCE 3-TIER, 10-PAIR RACK

Keep all of your ZIVA® dumbbells neatly organized in a dedicated space for easy access to maximize your workouts' efficiency. The ZIVA Performance 3-Tier, Hexagon Dumbbell Rack features heavy-duty oval steel tubing and floor-protecting feet to keep weights exactly where they are needed for exactly when they are needed. Its flat shelving and saddleless design offer a wide diversity of storage options.



Order Code	Item Description
ZFT-DBST-5124	Performance 3-Tier, 10-pair Hexagon Dumbbell Rack

Description		Performance Hexagon Dumbbell Rack
Specifications		Made with oval steel tubing 2mm thick, thick plate steel, welded frames, black- or chrome-colored hardware and PVC shelf lining
Storage		Fits Up to 10 pairs of hexagon dumbbells
Color Options		Black powder-coated finish
Dimensions		100cm x 61cm x 99cm - 36kg
Warranty		Limited 5 year warranty on frames and welding, 1 year on plastic parts







PERFORMANCE 2-TIER, 8-PAIR RACK

The perfect marriage of size and functionality, our 2-Tier Dumbbell Rack holds more than enough weight to guarantee users have what they need for an intense core, HIIT, or resistance training workout. Designed to match the overall aesthetic of ZIVA® gear and the specific look of our hexagon dumbbells, this rack not only keeps gyms perfectly organized but gives them a premium, elite-level look, as well.



Order Code
ZFT-DBST-5299

Item Description
Performance 2-Tier, 8-pair Hexagon Dumbbell Rack

Description		Performance Hexagon Dumbbell Rack
Specifications		Made with oval steel tubing 2mm thick, thick plate steel, welded frames, black- or chrome-colored hardware and PVC shelf lining
Storage		Fits Up to 8 pairs of hexagon dumbbells
Color Options		<input checked="" type="checkbox"/> Black powder-coated finish
Dimensions		180cm x 61cm x 82cm - 38kg
Warranty		Limited 5 year warranty on frames and welding, 1 year on plastic parts







PERFORMANCE 2-TIER, 10-PAIR RACK

The perfect size and functionality of our sturdy, heavy-gauge steel 2-Tier Dumbbell Rack is extended to hold a total of up to 10x pairs of dumbbells so users are guaranteed quick, easy access to the tools they need for an intense core, HIIT, and resistance training workout thanks to this excellent organizational tool. Designed to match the ZIVA® aesthetics of our hexagon dumbbells, this rack gives always fast access to equipment while delivering a world-class look and intuitive organization.



Order Code
ZFT-DBST-5353

Item Description
Performance 2-Tier, 10-pair Hexagon Dumbbell Rack

Description		Performance Hexagon Dumbbell Rack
Specifications		Made with oval steel tubing 2mm thick, thick plate steel, welded frames, black- or chrome-colored hardware and PVC shelf lining
Storage		Fits Up to 10 pairs of hexagon dumbbells
Color Options		<input checked="" type="checkbox"/> Black powder-coated finish
Dimensions		150cm x 61cm x 82cm - 38kg
Warranty		Limited 5 year warranty on frames and welding, 1 year on plastic parts









PERFORMANCE VIRGIN RUBBER DUMBBELL (1KG INCREMENTS)

Dumbbells are the centerpiece of any gym. In the hands of new users, this timeless piece of equipment immediately lends itself to exercises everyone is familiar with: dumbbell curls, bench press, lunges, shoulder raises, and more. For more experienced users, though, the humble dumbbell enable a near infinite array of muscle-building exercises. The ZIVA® Performance Virgin Rubber Dumbbells take this seemingly modest piece of exercise and equipment and upgrades it with long-lasting wear-resistant rubber-coated heads and rust- and corrosion-resistant chrome handles etched with grip-assisting knurling. No gym is complete without a set of dumbbells, and this set offers the complete package in understated black and gray with easy ID numbers in white.



Order Code	Item Description
ZFT-DBRB-4645-BKGY	Performance Virgin Rubber Dumbbell Set 1-10kg (10 pairs), 110kg







Description	 Performance Virgin Rubber Dumbbell
Specifications	 Made with premium rubber outer casing with solid steel heads and chrome handles
Handle	 Premium chrome handle
Color Options	  Black with grey and white
Increments	 1kg increments
Warranty	 Limited 2 year warranty

PERFORMANCE VIRGIN RUBBER DUMBBELLS (2.5 INCREMENTS)

Dumbbells are the centerpiece of any gym. In the hands of new users, this timeless piece of equipment immediately lends itself to exercises everyone is familiar with: dumbbell curls, bench press, lunges, shoulder raises, and more. For more experienced users, though, the humble dumbbell enable a near infinite array of muscle-building exercises. The ZIVA® Performance Virgin Rubber Dumbbells take this seemingly modest piece of exercise and equipment and upgrades it with long-lasting wear-resistant rubber-coated heads and rust- and corrosion-resistant chrome handles etched with grip-assisting knurling. No gym is complete without a set of dumbbells, and this set offers the complete package in understated black and gray with easy ID numbers in white.



Order Code	Item Description
ZFT-DBRB-4498-BKGY	Performance Virgin Rubber Dumbbell Set 2.5-12.5kg (5 pairs), 75kg
ZFT-DBRB-4645-BKGY	Performance Virgin Rubber Dumbbell Set 15-25kg (5 pairs), 200kg
ZFT-DBRB-4647-BKGY	Performance Virgin Rubber Dumbbell Set 27.5-37.5kg (5 pairs), 325kg
ZFT-DBRB-5061-BKGY	Performance Virgin Rubber Dumbbell Set 2.5-25kg (10-pairs), 275kg
ZFT-DBRB-5062-BKGY	Performance Virgin Rubber Dumbbell Set 27.5-50kg (10-pairs), 775kg
ZFT-DBRB-4786-BKGY	Performance Virgin Rubber Dumbbell Set 40-50kg (5 pairs), 450kg







Description	 Performance Virgin Rubber Dumbbell
Specifications	 Made with premium rubber outer casing with solid steel heads and chrome handles
Handle	 Premium chrome handle
Color Options	  Black with grey and white
Increments	 2.5kg increments
Warranty	 Limited 2 year warranty

PERFORMANCE 2-TIER 5-PAIR ROUND DUMBBELL RACK WITH SADDLES

The ZIVA® Performance 2-Tier, 5-Pair Rack with Saddles is specially designed with curved weight cradles to store and display the accompanying 5-pair Virgin Rubber Dumbbell Set. The dumbbells, with their classic, iconic design and long-lasting rubber-coated steel heads, nestle perfectly into the rack's sturdy PVC saddles and are easily racked and unracked thanks to the ergonomically angled shelving. The rack's sturdy steel gauge piping and shelves serve as both storage and a display that matches the premium ZIVA aesthetic, and its floor-protecting feet keep gym floors scuff-free.



Order Code	Item Description
ZFT-DBST-4998	Performance 2-Tier 5-Pair Round Dumbbell Rack with Saddles

Description	 Performance Round Dumbbell Rack with Saddles
Specifications	 Made with oval steel tubing 14 gauge thick, thick plate steel, welded frames, black or chromed coloured hardware and saddles
Product Color	  Black powder-coated finish
Storage	 Fits 5 pairs of round head dumbbells
Dimensions	 122cm x 61cm x 81.3cm - 44kg
Warranty	 Limited 5 year warranty on frames and welding, 1 year on plastic parts

PERFORMANCE 2-TIER 10-PAIR ROUND DUMBBELL RACK WITH SADDLES

The ZIVA® Performance 2-Tier, 10-Pair Rack with Saddles is specially designed with curved weight cradles to store and display 10-pair round dumbbells. The dumbbells, with their classic, iconic design and long-lasting rubber-coated steel heads, nestle perfectly into the rack's sturdy PVC saddles and are easily racked and unracked thanks to the ergonomically angled shelving. The rack's sturdy steel gauge piping and long shelves serve as both storage and a display that matches the premium ZIVA aesthetic, and its floor-protecting feet keep gym floors scuff-free.



Order Code ZFT-DBST-5366
Item Description Performance 2-Tier 10 Pair Round Dumbbell Rack with Saddles

Description		Performance Round Dumbbell Rack with Saddles
Specifications		Made with oval steel tubing 14 guage thick, thick plate steel, welded frames, black or chromed coloured hardware and sadles
Product Color		Black powder-coated finish
Storage		Fits 10-pairs of round head dumbbells
Dimensions		241.3cm x 61cm x 81.3cm - 64kg
Warranty		Limited 5 year warranty on frames and welding, 1 year on plastic parts

PERFORMANCE 3-TIER 10-PAIR ROUND DUMBBELL RACK WITH SADDLES

The ZIVA® Performance 3-Tier, 10-Pair Rack with Saddles is specially designed with curved weight cradles to store and display 10-pair round dumbbells. The dumbbells, with their classic, iconic design and long-lasting rubber-coated steel heads, nestle perfectly into the rack's sturdy PVC saddles and are easily racked and unracked thanks to the ergonomically angled shelving. The rack's sturdy steel gauge piping and shelves serve as a compact storage and display piece that matches the ZIVA aesthetic, and its floor-protecting feet keep gym floors scuff-free.



Order Code ZFT-DBST-5969
Item Description Performance 3 Tier 10 Pair Round Dumbbell Rack with Saddles

Description		Performance Round Dumbbell Rack with Saddles
Specifications		Made with oval steel tubing 14 guage thick, thick plate steel, welded frames, black or chromed coloured hardware and sadles
Product Color		Black powder-coated finish
Storage		Fits 10-pairs of round head dumbbells
Dimensions		144.8cm x 155cm x 104.1cm - 59kg
Warranty		Limited 5 year warranty on frames and welding, 1 year on plastic parts

NEOPRENE TRIBELLS

The ZIVA® Neoprene Tribell is a workout essential that features a sleek, non-slip, durable vinyl finish in a vibrant array of colors that is easy to spot from anywhere in a home gym or studio. It's precision-calibrated weight is evenly distributed across the tribell so hands never develop sore spots even as muscles fatigue, and its elite-level, commercial-quality guarantees it will remain part of your workout for years to come.



Order Code	Item Description	Order Code	Item Description
ZFT-NPHX-6580-BKGY	Neoprene Dumbbell 0.5kg	ZFT-NPHX-6583-BKGY	Neoprene Dumbbell 3kg
ZFT-NPHX-6581-BKGY	Neoprene Dumbbell 1kg	ZFT-NPHX-6584-BKGY	Neoprene Dumbbell 4kg
ZFT-VNHX-5849-BKGY	Neoprene Dumbbell 1.5kg	ZFT-NPHX-6585-BKGY	Neoprene Dumbbell 5kg
ZFT-NPHX-6582-BKGY	Neoprene Dumbbell 2kg		

Description		Neoprene Dumbbells
Specifications		Neoprene surface coating
Color Options		Black / Grey / White
Increments		0.5kg increments from 0.5-2kg and 1kg increments from 2-5kg
Warranty		Limited 2 year warranty

PERFORMANCE TRIBELL RACK

Able to hold a complete set of 10x pairs of Tribells gyms will be ready to serve HIIT and functional fitness enthusiasts. The tribells fit beautifully onto the heavy-duty 10-Pair Tribell Rack. Made with oval steel tubing and 2mm thick plate steel, the same ZIVA design language is evident across both, giving an unmistakably unified aesthetic that gives gyms a more premium look and feel.



Order Code	Item Description
ZFT-VS10-7721	Performance 1-10kg Tribell Rack

Description		Performance Tribell Rack
Specifications		Made with oval steel tubing, thick plate steel, welded frames, and padded saddles
Product Color		Black powder-coated finish
Storage		Fits up to 10 pairs neoprene tribells
Dimensions		50cm x 50cm x 122cm - 17kg
Warranty		Limited 5 year warranty on frames and welding, 1 year on plastic parts

PERFORMANCE PLUS 4-TIER STORAGE RACK

The Performance PLUS 4-Tier Storage Rack is a storage and display piece that features swivelling wheels for quick, easy movement around the gym. This mobile storage and display rack carries functional fitness equipment to target every body part, offering a comprehensive, full-body workout and moves easily anywhere its needed for quick, easy access to each piece. The 4-tiered rack is made from 2mm thick steel tubing and PVC-lined steel plate, is equipped with wheels. This all-in-one package makes it easy to move seamlessly from one personal training client to the next with minimal need for regathering or movement of equipment, so trainers can do more, faster, and with less effort.



Order Code
ZFT-MFSR-9648

Item Description
Performance PLUS 4-Tier Storage Rack

Description		Performance PLUS 4-Tier Storage Rack
Specifications		Horizontal style frame, 3mm thick oval tube steel and wheeled base for easy portability
Product Color		Black powder-coated finish
Dimensions		166cm x 84cm x 166cm - 110kg
Warranty		Limited 5 year warranty on frames and welding; 1 year on plastic parts

PERFORMANCE 4-TIER UNIVERSAL STORAGE RACK

The ZIVA® 4-Tier Universal Storage Rack provides a place for everything and helps keep everything in its place while also providing a display for elite-level training equipment. Made with 2mm thick steel tubing welded to thick, PVC-lined plate steel shelves, this rack neatly organizes all manner of medicine balls, kettlebells, dumbbells, core sandbags, and other equipment. With a design aesthetic that perfectly matches other ZIVA equipment, it's the perfect marriage of form and function.



Order Code
ZFT-MFSR-9885

Item Description
Performance 4-Tier Universal Storage Rack

Description		Performance 4-Tier Universal Storage Rack
Specifications		Made with oval steel tubing, thick plate steel, welded frames, black- or chrome-colored hardware and PVC shelf lining
Product Color		Black powder-coated finish
Dimensions		82cm x 84cm x 166cm - 60kg
Warranty		Limited 5 year warranty on frames and welding; 1 year on plastic parts

PERFORMANCE HALF RACK

Our Performance Half Rack with tough 60mm laser cut steel frame and wide, stable base delivers much of the functionality of a wall- or floor-mounted rig without necessitating any additional installation. Users can push themselves to new limits on squat, bench press, overhead press, and more without worrying what will happen if they have to do a rough re-rack; this heavy-duty rack is made to withstand the rigors of elite training day in, and day out.



Order Code	Item Description
ZFT-RKHF-0690-BKGY	Performance Half Rack
ZFT-RGAT-1435	Performance Safety Arm Attachment

Description		Performance Half Rack
Specifications		Made with 70 x 70mm steel tubing 3mm thick, thick plate steel, welded frames, 20mm black-colored hardware
Product Color		 Black powder-coated finish
Dimensions		121cm x 140cm x 241cm - 75kg
Warranty		Limited 10 year warranty on frames and welding; 1 year on plastic parts







OLYMPIC BARS

The Olympic Bar has been the basis for any weight training routine since weight training as a discipline was first born. ZIVA® has taken this ageless yet elite piece of exercise equipment and fitted it with needle roller bearings for smooth, even, easy rotation during lifts, etched it with grip-assisting knurling, and finished it with either understated, modern, black oxide or sleek, stylish chrome. ZIVA Olympic Bars fit all Olympic-sized weight discs and come with capped ends for reduced maintenance needs. Turning your home gym into an elite, heavy-weight training studio begins here.





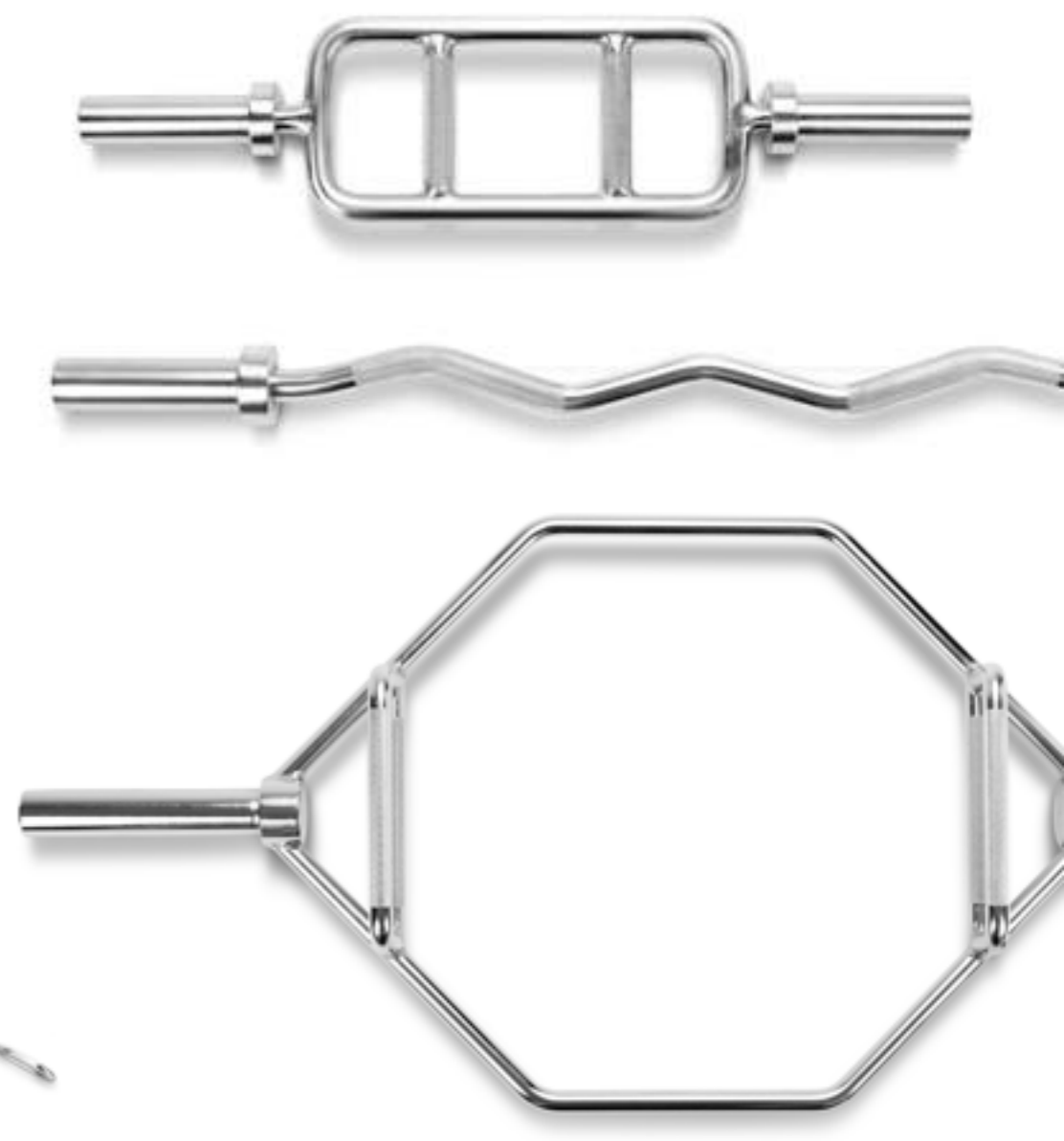

Order Code	Item Description
ZFT-LBHC-2950-BK	Performance Olympic Black Oxide Bar 2.2m
ZFT-LBHC-2950-SV	Performance Olympic Chrome Bar 2.2m
ZFT-LBHC-2953	Olympic Chrome Bar 1.8m
ZFT-LBHC-2954	Olympic Chrome Bar 1.5m

Description	 Performance Olympic Bars
Specifications	 Made from alloy steel with either chromed or black oxide surface finish
Product Color	 <input checked="" type="checkbox"/> Black oxide <input type="checkbox"/> Chrome
Handle	 Knurled grips
Weight Loading	 Check the listings below for weight limits



Order Code	Item Description
ZFT-HCOB-2965	Olympic Chrome Tricep Bar 76cm
ZFT-HCOB-2966	Olympic Chrome EZ Curl Bar 1.2m
ZFT-PBHC-2936	Olympic Chrome Hex Trap Bar 1.4m
ZFT-OBST-0373	Olympic Spring Collar 100g
ZFT-OBCC-0436	Olympic Clamp Collars



Description	 Olympic Bars
Specifications	 Made from alloy steel with either chromed or black oxide surface finish
Product Color	 <input type="checkbox"/> Chrome
Handle	 Knurled grips
Weight Loading	 Check the listings below for weight limits



Order Code	ZFT-LBHC-2950-BK/SV
Item Description	Performance Olympic Bar 7'
Weight	20kg
Capacity	331kg
Bar Diameter	3cm
Length	2.2m
Sleeve Length	5cm diameter; 44.5cm long



Order Code	ZFT-LBHC-2953
Item Description	Olympic Chrome Bar 6'
Weight	16kg
Capacity	150kg
Bar Diameter	3cm
Length	1.8m
Sleeve Length	5cm diameter; 24cm long



Order Code	ZFT-LBHC-2954
Item Description	Olympic Chrome Bar 5'
Weight	13kg
Capacity	150kg
Bar Diameter	2.7cm
Length	1.5m
Sleeve Length	5cm diameter; 27cm long



Order Code	ZFT-HCOB-2965
Item Description	Olympic Chrome Tricep Bar 30''
Weight	14kg
Capacity	150kg
Bar Diameter	2.5cm
Length	76cm
Sleeve Length	5cm diameter; 20cm long



Order Code	ZFT-HCOB-2966
Item Description	Olympic Chrome EZ Curl Bar 47''
Weight	10kg
Capacity	150kg
Bar Diameter	3cm
Length	1.2m
Sleeve Length	5cm diameter; 20cm long

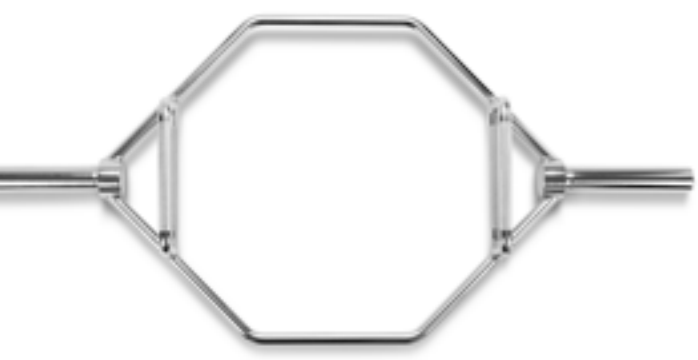

Order Code	ZFT-PBHC-2936
Item Description	Olympic Chrome Hex Trap Bar 55''
Weight	20kg
Capacity	150kg
Bar Diameter	3cm
Length	1.4m
Sleeve Length	5cm diameter; 56cm long

PERFORMANCE RUBBER BUMPER PLATE

Extreme toughness that bounces back and never folds under pressure: that's the hallmark of our Performance Rubber Bumper Plates. Ultra-durable, premium rubber coating covers precision-calibrated iron weights with Olympic-sized wear-, rust-, and corrosion-resistant chrome-plated hubs on these plates specially designed for HIIT, cross-training, and Olympic lifting. Even when dropped from a height, these rubber plates with beveled edges won't scratch up floors or walls, or harm the bar or surrounding equipment.



Order Code	ZFT-RBBP-7639-BKGY
Item Description	Performance Rubber Bumper Plate (5, 10, 15, 20, 25kg) x 2 Set + Olympic Chrome Bar 2.2m

Description	 Performance Rubber Bumper Plate
Specifications	 Made with premium virgin rubber outer casing and cast iron cores
Color Options	  Black with grey and white
Increments	 5kg increments
Warranty	 Limited 2 year warranty

PERFORMANCE OLYMPIC BAR RACK

The Olympic Bar is the basis for any weight training program, but can make a gym feel cluttered and disorganized if not properly kept. The ZIVA® Performance Olympic Bar Rack, crafted with heavy-duty steel plate with a long-lasting powder-coated finish, keeps up to 6x bars perfectly arranged in a vertical configuration that takes up minimum floor space for maximum efficiency.



Order Code
ZFT-OBSS-5114

Item Description
Performance Olympic Bar Rack (6 pieces)

Description		Performance Olympic Bar Rack
Specifications		Olympic Bar Rack made from steel plate
Color Options		<input checked="" type="checkbox"/> Black powder-coated finish
Storage		Fits up to 6 Olympic bars
Dimensions		46cm x 40cm x 20cm - 15kg
Warranty		Limited 5 year warranty on frames and welding; 1 year on plastic parts

PERFORMANCE DISC STORAGE RACK FOR 18 PLATES

Created to meet the demands of the most dedicated athletes, whether they be powerlifters, bodybuilders, or faithful fans of functional fitness, this ZIVA® Performance Disc Storage Rack can hold up to 18 bumper plates or grip discs and two standard Olympic barbells. Keep your gym's elite-level equipment right where it is needed, perfectly organized and ready for the next personal best.



Order Code
ZFT-ODRK-4015

Item Description
Performance Disc Storage Rack 18 Plates

Description		Performance Disc Storage Rack
Specifications		Made with oval steel tubing 2mm thick, thick plate steel, welded frames, black- or chrome-colored hardware and PVC shelf lining
Color Options		<input checked="" type="checkbox"/> Black powder-coated finish
Storage		Fits up to 18 bumper plates or grip discs
Dimensions		72cm x 70cm x 132cm - 25kg
Warranty		Limited 5 year warranty on frames and welding; 1 year on plastic parts

PERFORMANCE CABLE ATTACHMENTS

The ZIVA® Performance Cable Attachments features all the handles and bars necessary to make the absolute most out of a cable weight set up. The complete pack features 5x lat bars of varying length that offer a broad range of grips; straight, angled, and bent triceps bars so users can target tris from several different angles; single- and double-sided rope attachments; and the classic stirrup handle and seated row double-handle. All bars are made with a scratch-resistant chrome finish and comfortable, long-lasting PU grip for a premium look and feel.



Order Code	Item Description	Order Code	Item Description
ZXP-TCRB-6516	1 Performance Hard Chrome Short Lat Bar with PU Grip - 78cm	ZXP-MTBR-6514	8 Performance Hard Chrome Multi-Exercise Bar with PU Grip
ZXP-SRDH-6619	2 Performance Hard Chrome Seated Row Double Handle	ZXP-TCVR-6513	9 Performance Hard Chrome Bent Tricep Bar with PU Grip - 54cm
ZXP-LTBR-6509	3 Performance Hard Chrome Medium Lat Bar with PU Grip - 95cm	ZXP-ATCB-6620	10 Performance Hard Chrome Angled Tricep Bar with PU Grip
ZXP-LTBR-6511	4 Performance Hard Chrome Long Lat Bar with PU Grip - 120cm	ZXP-PLBR-6512	11 Performance Hard Chrome Short Lat Bar with PU Grip - 76cm
ZXP-TCSB-6616	5 Performance Hard Chrome Straight Trcep Bar with PU Grip - 43cm	ZXP-AKST-0228	12 Ankle Strap
ZXP-CBHD-6621	6 Performance Hard Chrome Stirrup Handle	ZXP-STCR-6510	13 Performance Single Rope
ZXP-PLBR-6518	7 Performance Hard Chrome Long Lat Bar with PU Grip - 96cm	ZXP-DTCR-6610	14 Performance Double Tricep Rope
		ZXP-STHD-1437	15 Strap Handle

Description		Performance Cable Attachments
Specifications		Assorted cable station attachments
Handle		Premium chrome bars with TPE handle
Color Options		Chrome with dark grey grips
Warranty		Limited 1 year warranty

PERFORMANCE CABLE ATTACHMENTS

The ZIVA® Performance Cable Attachments features all the handles and bars necessary to make the absolute most out of a cable weight set up. The complete pack features 5x lat bars of varying length that offer a broad range of grips; straight, angled, and bent triceps bars so users can target tris from several different angles; single- and double-sided rope attachments; and the classic stirrup handle and seated row double-handle. All bars are made with a scratch-resistant chrome finish and comfortable, long-lasting PU grip for a premium look and feel.

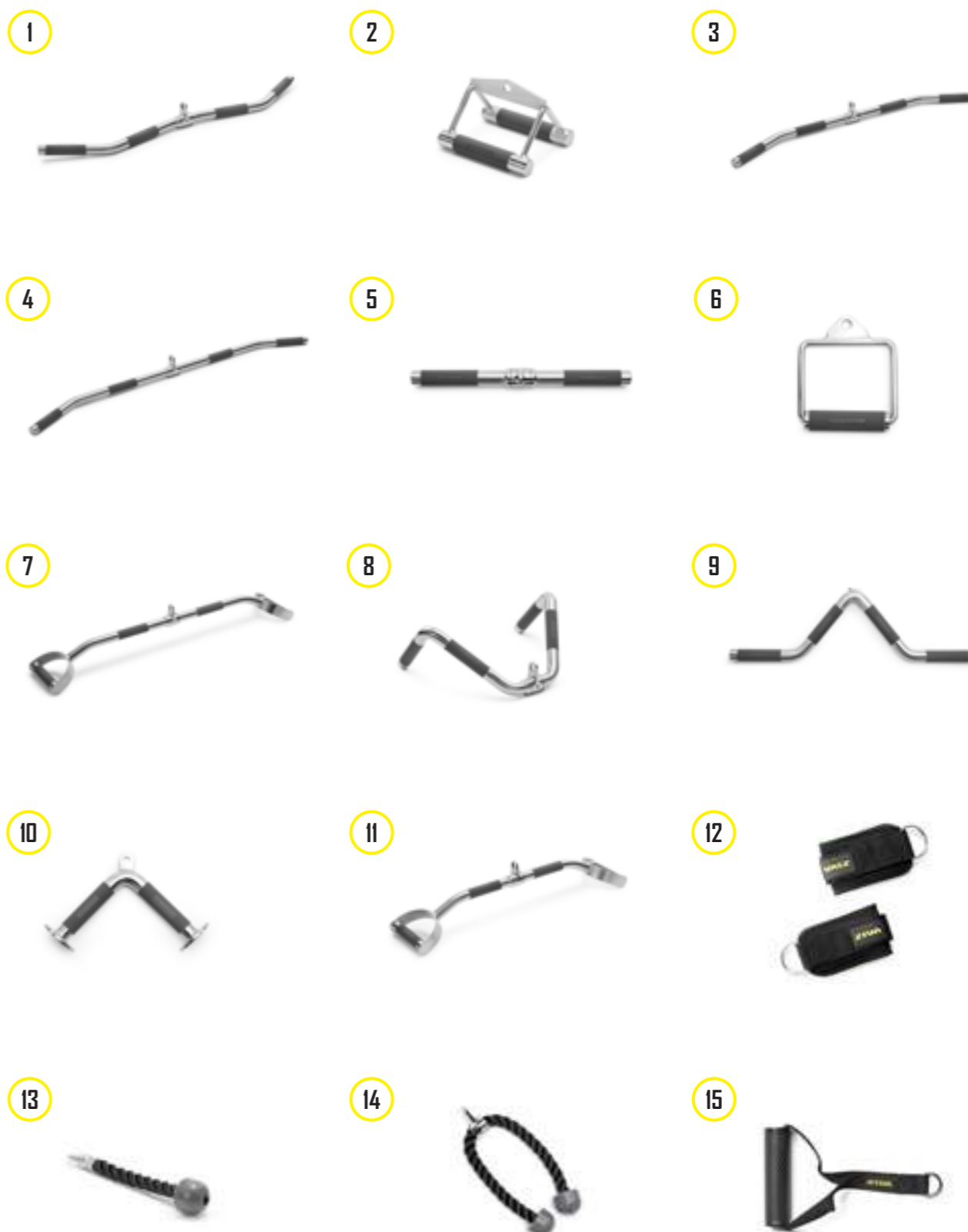







PERFORMANCE CABLE ATTACHMENT RACK (3 TIER)

The ZIVA® Cable Attachment Rack is the perfect antidote to the seemingly inevitable clutter around every cable weight set up. Crafted from powder-coated thick plate steel and steel tubing with J-Cups to cradle all bar attachments, it has space enough to keep every variation of cable attachment stored, displayed, and optimally organized so users can find what they are looking for fast and the gym can stay looking fantastic.



Order Code	Item Description
ZFT-CARK-0880	Performance Cable Attachment Rack (3 Tier)









Description		Performance Cable Attachment Rack (3 Tier)
Specifications		Made with oval steel tubing, thick plate steel, welded frames
Color Options		 Black powder-coated finish
Storage		Fits ZIVA Performance cable attachments
Dimensions		50 x 50 x 100cm - 24kg
Warranty		Limited 5 year warranty on frames, 1 year on plastic parts

PERFORMANCE POWER CORE BAG

The often under appreciated yet extremely versatile and powerful classic sandbag is a multipurpose functional strength training tool with numerous benefits that are not possible to realize through traditional barbell training alone. The ZIVA® Performance Power Core Bag takes this dynamic, less easily controlled resistance that recruits more stabilizer muscles across the entire body, and updates it with heavy-duty nylon straps, a thick PVC skin, and large, easy identification weights numbers. This highly flexible tool allows users to enjoy a wide variety of compound lifts and combined compound lifts, a dream for full-body superset routines.



Order Code	Item Description	Order Code	Item Description
ZFT-SPPB-9930	Performance Power Core Bag 5kg	ZFT-SPPB-9935	Performance Power Core Bag 17.5kg
ZFT-SPPB-9931	Performance Power Core Bag 7.5kg	ZFT-SPPB-9936	Performance Power Core Bag 20kg
ZFT-SPPB-9932	Performance Power Core Bag 10kg	ZFT-SPPB-9944	Performance Power Core Bag 22.5kg
ZFT-SPPB-9933	Performance Power Core Bag 12.5kg	ZFT-SPPB-9937	Performance Power Core Bag 25kg
ZFT-SPPB-9934	Performance Power Core Bag 15kg		

Description		Performance Power Core Bag
Specifications		Made with hard-wearing PVC outer skin and encapsulated sand-filled inner core
Color Options		 Black /  Grey /  White
Increments		2.5kg increments
Warranty		Limited 1 year warranty









ZIVA

PERFORMANCE WALL BALL

Full-body strength, coordination, and intense cardio combine in one durable, elite-level tool guaranteed to push performance to its absolute limits. The ZIVA® Performance Wall Ball may seem simple, but when used properly it engages the entire body and builds explosive power alongside cardiovascular endurance and quick reflexes. The wall ball's simplicity allows for a wide range of different compound motions to be paired with throwing and catching, with weights chosen to emphasize explosive power or endurance and speed.



Order Code	Item Description	Order Code	Item Description
ZFT-FTWB-9271-YL	Performance Wall Ball 2kg	ZFT-FTWB-9276-YL	Performance Wall Ball 7kg
ZFT-FTWB-9272-YL	Performance Wall Ball 3kg	ZFT-FTWB-9277-YL	Performance Wall Ball 8kg
ZFT-FTWB-9273-YL	Performance Wall Ball 4kg	ZFT-FTWB-9278-YL	Performance Wall Ball 9kg
ZFT-FTWB-9274-YL	Performance Wall Ball 5kg	ZFT-FTWB-9279-YL	Performance Wall Ball 10kg
ZFT-FTWB-9275-YL	Performance Wall Ball 6kg	ZFT-FTWB-9289-YL	Performance Wall Ball 12kg







Description		Performance Wall Ball
Specifications		Made with hard-wearing PVC outer skin and heavy-duty fiber core with encapsulated sand weight
Color Options		 Black / Grey / White
Increments		1kg increments and 12kg
Warranty		Limited 1 year warranty

PERFORMANCE MEDICINE BALL

One of history's oldest and most versatile fitness tools, the medicine ball has been used for centuries to build explosive power and total-body strength for sport-specific training as well as general physical fitness. The ZIVA® Medicine Ball takes this timeless tool and brings it into the modern age with precision-calibrated weighting; premium-quality, easy-grip textured rubber; and vibrant, easy to ID numbering.



Order Code	Item Description	Order Code	Item Description
ZFT-CMMB-9061-BKGY	Performance Medicine Ball 2kg	ZFT-CMMB-9066-BKGY	Performance Medicine Ball 7kg
ZFT-CMMB-9062-BKGY	Performance Medicine Ball 3kg	ZFT-CMMB-9067-BKGY	Performance Medicine Ball 8kg
ZFT-CMMB-9063-BKGY	Performance Medicine Ball 4kg	ZFT-CMMB-9068-BKGY	Performance Medicine Ball 9kg
ZFT-CMMB-9064-BKGY	Performance Medicine Ball 5kg	ZFT-CMMB-9069-BKGY	Performance Medicine Ball 10kg
ZFT-CMMB-9065-BKGY	Performance Medicine Ball 6kg		

Description		Performance Medicine Ball
Specifications		Made with premium rubber
Color Options		 Black / Grey / White
Increments		1kg increments
Warranty		Limited 1 year warranty

PERFORMANCE 8 PIECE STORAGE TREE

The ZIVA® Performance Wall Ball 8-Piece Set, with 8x pieces in 1kg increments from 2-9kg, features heavy-duty fiber cores weighted with sand and wrapped in hard-wearing, high durability PVC skins. These long-lasting functional fitness tools help users build explosive power alongside cardiovascular endurance and quick reflexes. The accompanying 8-Piece Storage Tree not only cradles each piece with 2mm thick steel tubing, but also serves as an eye-catching display that matches the equipment's aesthetic for a fantastic fusion of form and function.



Order Code
ZFT-MDRK-6031

Item Description
Performance Storage Tree (8 pieces)

Description		Performance Storage Tree
Specifications		Made with oval steel tubing, welded frames, black or chromed coloured hardware
Color Options		Black powder-coated finish
Storage		Fits up to 8x wall balls
Dimensions		85cm x 51cm x 147cm - 24kg
Warranty		Limited 5 year warranty on frames and welding; 1 year on plastic parts

PERFORMANCE 10 PIECE STORAGE TREE

The ZIVA® Performance Wall Ball 10-Piece Set, with 9 pieces in 1kg increments from 2-10kg and a heavy-duty 12kg ball, features fiber cores weighted with sand and wrapped in hard-wearing, high durability PVC skins. These long-lasting functional fitness tools help users build explosive power alongside cardiovascular endurance and quick reflexes. The accompanying 10-Piece Storage Tree not only cradles each piece with 2mm thick steel tubing, but also serves as an eye-catching display that matches the equipment's premium aesthetic for a fantastic fusion of form and function.



Order Code
ZFT-MDRK-6028

Item Description
Performance Storage Tree (10 pieces)

Description		Performance Storage Tree
Specifications		Made with oval steel tubing, welded frames, black or chromed coloured hardware
Color Options		Black powder-coated finish
Storage		Fits up to 10x wall balls
Dimensions		101cm x 51cm x 163cm - 26kg
Warranty		Limited 5 year warranty on frames and welding; 1 year on plastic parts



PERFORMANCE SLAM BALL

Full-body strength and endurance; intense, explosive cardio; and challenging rotational core exercises combine in one durable, elite-level tool guaranteed to push performance to its absolute limits. The ZIVA® Performance Slam Ball features a weighted, sand-filled center wrapped in a tough PVC shell with gripping tire tread skin, and is made to be thrown with abandon over and over again. Overhead slams, woodchoppers, Russian twists, and more unique full-body exercises test the limits of users' core strength and endurance while building shoulder, chest, arm, and leg muscle in a holistic fashion that includes often neglected supporting and stabilizer muscles.



Order Code	Item Description	Order Code	Item Description
ZFT-SPSB-6870	Performance Slam Ball 2kg	ZFT-SPSB-6877	Performance Slam Ball 9kg
ZFT-SPSB-6871	Performance Slam Ball 3kg	ZFT-SPSB-6878	Performance Slam Ball 10kg
ZFT-SPSB-6872	Performance Slam Ball 4kg	ZFT-SPSB-6879	Performance Slam Ball 12kg
ZFT-SPSB-6873	Performance Slam Ball 5kg	ZFT-SPSB-6998	Performance Slam Ball 14kg
ZFT-SPSB-6874	Performance Slam Ball 6kg	ZFT-SPSB-6999	Performance Slam Ball 16kg
ZFT-SPSB-6875	Performance Slam Ball 7kg	ZFT-SPSB-6881	Performance Slam Ball 18kg
ZFT-SPSB-6876	Performance Slam Ball 8kg	ZFT-SPSB-6882	Performance Slam Ball 20kg

Description		Performance Slam Ball
Specifications		Made with hard-wearing PVC skin and sand and iron filler
Color Options		Black / Grey
Increments		1kg increments from 2-10kg and 2kg increments from 10-20kg
Warranty		Limited 1 year warranty

PERFORMANCE SLAM BALL 5-PIECE STORAGE TREE

The ZIVA® Performance Slam Ball 5-Piece Set features precision-weighted, sand-filled centers wrapped in a tough PVC shell with gripping tire tread skin, and comes in 2kg increments from 3-11kg or 4-12kg. These hardcore functional fitness tools are made to be thrown with abandon over and over again with overhead slams, woodchoppers, Russian twists, and other full-body exercises for shoulder, chest, arm, and leg muscle development. The accompanying 5-Piece Storage Tree, with 2mm thick steel tubing, cradles and displays each ball, and features floor-protecting feet that prevent scuffing to keep the gym looking great.



Order Code	Item Description
ZFT-MDRK-6008	Performance Slam Ball Tree (5 pieces)







Description		Performance Storage Tree
Specifications		Made with round steel tubing, welded frames, black or chromed coloured hardware
Color Options		Black powder-coated finish
Storage		Fits up to 5x slam balls
Dimensions		56cm x 47cm x 154cm - 13kg
Warranty		Limited 5 year warranty on frames and welding; 1 year on plastic parts

PERFORMANCE SLAM BALL 10-PIECE STORAGE TREE

The ZIVA® Performance Slam Ball 10-Piece Set features precision-weighted, sand-filled centers wrapped in a tough PVC shell with gripping tire tread skin, and comes in 1kg increments from 2-10kg with a heavy 12kg ball. These hardcore functional fitness tools are made to be thrown with abandon over and over again with overhead slams, woodchoppers, Russian twists, and other full-body exercises for shoulder, chest, arm, and leg muscle development. The accompanying 10-Piece Storage Tree, with 2mm thick steel tubing, cradles and displays each ball, and features floor-protecting feet that prevent scuffing to keep the gym looking great.



Order Code	Item Description
ZFT-MDRK-6009	Performance Slam Ball Tree (10 pieces)







Description		Performance Storage Tree
Specifications		Made with round steel tubing, welded frames, black or chromed coloured hardware
Color Options		<input checked="" type="checkbox"/> Black powder-coated finish
Storage		Fits up to 10x slam balls
Dimensions		101cm x 51cm x 163cm - 26kg
Warranty		Limited 5 year warranty on frames and welding; 1 year on plastic parts

PERFORMANCE 3-TIER, BALL STORAGE RACK

The ZIVA® Performance 3-Tier Ball Storage Rack, with 3x shelves crafted from sturdy 2mm thick steel tubing and a scratch-, wear-, rust-, and corrosion-resistant black powder-coating finish, serves not only as a mobile organizational tool for up to 12x exercise balls of varying size, but also offers a great way to display balls. Thanks to a shared design language, the rack looks best when paired with ZIVA Slam, Wall, Medicine, or other balls.



Order Code	Item Description
ZFT-TBSR-7229	Performance 3 Tier Ball Storage Rack

Description		Performance 3-Tier Ball Storage Rack
Specifications		Made with round steel tubing, welded frames, black or chromed coloured hardware
Color Options		<input checked="" type="checkbox"/> Black powder-coated finish
Storage		Fits up to 12x small exercise balls
Dimensions		162cm x 55cm x 150cm - 34kg
Warranty		Limited 5 year warranty on frames and welding; 1 year on plastic parts



12
ZIVA

PERFORMANCE POWER TWIST BAG

The ZIVA® Performance Power Twist Bag Set features 5x precision-weighted pieces at 4, 8, 12, 16, and 20kg. With high durability, reinforced PVC outer skin and a fiber core wrapped around its inner weighted sandbag, each one of these functional fitness tools features both sturdy nylon straps and PVC-skinned, grip-challenging handles so users can easily train hands, grip, and wrists as well as arms, shoulders, lengths, and all rotational muscles.



Order Code	Item Description
ZFT-FTBG-2194	Performance Power Twist Bag 5kg
ZFT-FTBG-2195	Performance Power Twist Bag 8kg
ZFT-FTBG-2196	Performance Power Twist Bag 12kg
ZFT-FTBG-2197	Performance Power Twist Bag 17kg
ZFT-FTBG-2198	Performance Power Twist Bag 20kg

Description		Performance Power Twist Bag
Specifications		Made with hard-wearing PVC outer skin and encapsulated sand-filled inner core
Color Options		Black / Grey / White
Increments		4kg increments from 4kg - 12kg plus 17kg and 20kg
Warranty		Limited 1 year warranty

PERFORMANCE POWER SAND BAG

The ZIVA® Performance Power Sandbag is available in 2.5kg increments from 5-20kg with an extra-heavy 25kg bag. These functional fitness tools, perfect for group training and teaching complex compound movements while also strengthening crucial stabilizer muscles, are made with a hard-wearing yet soft-to-the-touch polyester outer casing around a rubber-encased sand and metal filling. Tough, high durability handles on all size allow for greater versatility of movement so users can do even more with less.



Order Code	Item Description	Order Code	Item Description
ZFT-SPPB-9950	Performance Power Sand Bag 5kg	ZFT-SPPB-9954	Performance Power Sand Bag 15kg
ZFT-SPPB-9951	Performance Power Sand Bag 7.5kg	ZFT-SPPB-9955	Performance Power Sand Bag 17.5kg
ZFT-SPPB-9952	Performance Power Sand Bag 10kg	ZFT-SPPB-9956	Performance Power Sand Bag 20kg
ZFT-SPPB-9953	Performance Power Sand Bag 12.5kg	ZFT-SPPB-9957	Performance Power Sand Bag 25kg

Description		Performance Power Sand Bag
Specifications		Made from hard-wearing soft touch polyester outer casing and encased sand and metal filling
Color Options		Black / Grey / White
Increments		2.5kg increments and 25kg
Warranty		Limited 1 year warranty

PERFORMANCE STUDIO BARBELL SET

The ZIVA® Performance Studio Barbell Set is the perfect package to help beginners start off the right way along their fitness journey; the studio barbell with intuitive, easy-to-use studio bar-sized clamp collars allow for intense muscle isolation exercises like biceps curls, triceps extensions, and lunges as well as compound lifts such as presses, rows, squats, and deadlifts, and the included RPU weight discs adding up to 19.5kg give users plenty of room to grow stronger.



Order Code	Item Description
ZFT-PRBS-7080	ZIVA Performance Studio Barbell 19.5kg Set
ZVO-STCL-0438	Studio Monster Clamp Collar

Description		Performance Studio Barbell
Specifications		Discs made with premium rubberized polyurethane with cast core, chromed studio bar and PP collars
Handle		Premium chrome handle
Increments		1.25kg, 2.5kg, and 5kg increments
Color Options		Black with grey and white
Warranty		Limited 1 year warranty

PERFORMANCE STUDIO BARBELL RACK

The ZIVA® Performance Studio Barbell Rack is a single-package solution for group training classes. The full set can store 10x Performance Studio Barbell Sets consisting of 10x studio bars, 20x studio bar clamps, and 10x sets of 19.5kg (2x 1.25, 2x 2.5, 2x 5) of RPU discs, all of which fit perfectly onto the heavy-duty rack made from oval steel tubing and thick steel plate. All this high-quality equipment speaks with the same design language, as well, giving gyms a wonderful, unified premium aesthetic.



Order Code	Item Description
ZFT-SB10-6005	Performance 10-Set Studio Barbell Rack

Description		Performance Studio Barbell Rack
Specifications		Made with oval steel tubing, thick plate steel, welded frames, black or chromed colored hardware
Product Color		Black powder-coated finish
Storage		Fits up to 10x performance studio barbells and plates
Dimensions		74cm x 54cm x 138cm - 26kg
Warranty		Limited 10 year warranty on frames and welding, 1 year on plastic parts



PERFORMANCE BOXING PUNCHING BAG / PERFORMANCE BOXING GLOVES

The ZIVA® Performance Boxing delivers superior quality on the essentials any gym needs to begin offering intense, high energy boxing workouts: the Performance Boxing Punching Bag (available in sets of 2x or 4x) with a high durability premium synthetic leather skin and nylon strapping, and Boxing Gloves (available in sets of 5x or 10x) that use the same premium quality synthetic leather covering over a shock absorbing PU inner core. Whether for personal training for individuals or group boxing classes, the Performance Boxing Set offers a single-package solution.



Order Code	Item Description
ZFT-MLPG-2572	Performance Boxing Punching Bag
ZFT-BDGG-2580	Performance Boxing Bandage Gloves
ZFT-MLBG-2577	Performance Boxing Gloves
ZFT-BDGE-2579	Performance Boxing Hand Wraps

Description		Performance Boxing Punching Bag / Performance Boxing Gloves
Specifications		- Performance Boxing Punching Bag is made with synthetic leather cover, nylon strapping, and mixed filler material - Performance Boxing Gloves are made with synthetic leather outer cover and PU inner core
Product Color		Black and white
Warranty		Limited 1 year warranty

STUDIO MAT RACK WITH CASTERS

The ZIVA® Studio Mat Rack with Casters makes storage for classes easy and mobile. Crafted from steel tubing with a rust- and scratch-resistant black powder coat, this Mat Rack features holding pegs on both sides for enough storage space to cover classes of up to 20x participants, and comes with 4x PE wheels making movement simple and easy.



Order Code	Item Description
ZFT-MTRK-0198	Studio Mat Rack with casters

Description		Studio Mat Rack with casters
Specifications		Made with oval steel tubing, thick plate steel, welded frames, black or chromed colored hardware
Color Options		Black powder-coated finish
Storage		Fits ZIVA Yoga Mats with Eyelets
Dimensions		92.5 x 64 x 186.5 cm - 19kg
Warranty		Limited 5 year warranty on frames and welding, 1 year on plastic parts

TPE YOGA MAT WITH EYELET

The ZIVA® TPE Yoga Mat with Eyelet delivers a non-toxic, eco-friendly, highly comfortable mat with no-slip grip that's easy to hang by its eyelets so the gym stays clean and uncluttered. Made with low-impact, high-durability recyclable TPE and without any latex or harsh chemicals, this mat delivers peace to both mind and body with its thick, soft, double-layered premium construction that relieves pressure on floor contact points and minimizes discomfort. A ribbed bottom and textured top give all-around slip coverage and comfort.



Order Code	Item Description
ZFT-TDYM-0230-BK	TPE Yoga Mat 5mm with eyelet
ZFT-MTRK-0199	Studio Mat Rack

Description		TPE Yoga Mat
Specifications		Made from TPE
Color Options		 Grey
Dimensions		165 X 61 X 0.5cm
Warranty		Limited 6 month warranty

PVC MATS WITH EYELET

The ZIVA® PVC Yoga Mat with Eyelet delivers an extra-thick, extra-comfortable mat with no-slip grip that's easy to hang by its eyelets so the gym stays clean and uncluttered. Made to maximize pressure relief on floor contact points and minimize discomfort, its ribbed bottom and textured top give all-around slip coverage to guarantee a great yoga workout.



Order Code	Item Description
ZFT-PVYM-6249	PVC Mat 175 x 60 x 0.8 cm with eyelet
ZFT-MTRK-0199	Studio Mat Rack

Description		PVC Mat with Eyelet
Specifications		Made from PVC
Color Options		 Black
Dimensions		175 x 60 x 0.8 cm
Warranty		Limited 6 month warranty



PERFORMANCE CORE-FIT BALL

With the right tools, training becomes a part of everyday life, and our Core Fit Ball makes it easy. Add it to any weight-focused workout to challenge users and increase recruitment of stabilizer muscles; or make it the centerpiece of core workouts for maximum muscle-building across the entire abdominal wall, easily and efficiently targeting the abs, obliques, and erectors. Designed with a non-slip, easy to grip surface and made with BPA-free PVC, the ZIVA® Core Fit Ball comes in different sizes for different body types, but all are tested up to 1000 lbs. so workout sessions stays safe no matter how intense.



Order Code	Item Description
ZFT-ABCB-9291	Performance 55cm Core-Fit Ball
ZFT-ABCB-9270	Performance 65cm Core-Fit Ball
ZFT-ABCB-9292	Performance 75cm Core-Fit Ball
ZFT-YBST-2623	Single Wall Mounted Anti-Burst Core-Fit Ball rack

Description		Performance Core-Fit Ball
Specifications		Made from heavy-duty and durable PVC
Product Color		Black with white
Warranty		Limited 6 month warranty

PERFORMANCE VIRGIN RUBBER KETTLEBELL

The kettlebell is a beautifully simple, full-body strength-building and conditioning tool. The ZIVA® Performance Virgin Rubber Kettlebell takes this already perfect tool and enhances it with advanced wear-, rust-, and corrosion-resistant virgin rubber coating that falls more softly than its conventional unadorned counterparts, making it ideal for any gym. Its ultra-durable chrome grip is less prone to dings and scratches than cast iron or plastic, and is designed without knurling to challenge and strengthen your grip. The Performance Virgin Rubber Kettlebell is an ideal tool for high performance, high intensity training.



Order Code	Item Description	Order Code	Item Description
ZFT-RBKB-4320-BKGY	Performance Virgin Rubber Kettlebell 4kg	ZFT-RBKB-4326-BKGY	Performance Virgin Rubber Kettlebell 16kg
ZFT-RBKB-4321-BKGY	Performance Virgin Rubber Kettlebell 6kg	ZFT-RBKB-4327-BKGY	Performance Virgin Rubber Kettlebell 20kg
ZFT-RBKB-4322-BKGY	Performance Virgin Rubber Kettlebell 8kg	ZFT-RBKB-4328-BKGY	Performance Virgin Rubber Kettlebell 24kg
ZFT-RBKB-4323-BKGY	Performance Virgin Rubber Kettlebell 10kg	ZFT-RBKB-4329-BKGY	Performance Virgin Rubber Kettlebell 28kg
ZFT-RBKB-4324-BKGY	Performance Virgin Rubber Kettlebell 12kg	ZFT-RBKB-4330-BKGY	Performance Virgin Rubber Kettlebell 32kg
ZFT-RBKB-4325-BKGY	Performance Virgin Rubber Kettlebell 14kg		

Description		Performance Virgin Rubber Kettlebell
Specifications		Made with premium virgin rubber outer casing with cast inserts
Handle		Premium chrome handle
Color Options		Black with grey and white
Increments		2kg increments up to 16kg, 4kg increments from 20kg to 32kg
Warranty		Limited 2 year warranty

PERFORMANCE COMPETITION KETTLEBELL

The kettlebell is a beautifully simple, full-body strength-building and conditioning tool. ZIVA® Performance Competition Kettlebells take this conventionally unadorned iron ball and add an eye-catching splash of competition color. With rust- and corrosion-resistant paint in pink, blue, yellow, purple, green, orange, and red, its ultra-durable chrome handle helps build grip strength and is less prone to dings and scratches than cast iron or plastic. These iconic, boldly styled kettlebells are gym centerpieces worthy display, and even more worthy of great competition.



Order Code	Item Description	Order Code	Item Description
ZFT-CTKB-6643	Performance Competition Kettlebell 8kg	ZFT-CTKB-6647	Performance Competition Kettlebell 20kg
ZFT-CTKB-6644	Performance Competition Kettlebell 10kg	ZFT-CTKB-6648	Performance Competition Kettlebell 24kg
ZFT-CTKB-6645	Performance Competition Kettlebell 12kg	ZFT-CTKB-6649	Performance Competition Kettlebell 28kg
ZFT-CTKB-6667	Performance Competition Kettlebell 14kg	ZFT-CTKB-6650	Performance Competition Kettlebell 32kg
ZFT-CTKB-6646	Performance Competition Kettlebell 16kg		

Description		Performance Competition Kettlebell
Coating		Precision steel bell with premium urethane surface coating
Color Options		(8kg - pink) (10kg - pink) (12kg - blue) (14kg - blue) (16kg - yellow) (20kg - purple) 24kg - green) (28kg - orange) (32kg - red)
Increments		2kg increments from 8kg - 16kg and 4kg increments from 20kg - 32kg
Handle		Steel handle
Warranty		Limited 2 year warranty

PERFORMANCE KETTLEBELL STORAGE RACK

The 2-Tier Kettlebell Storage Rack serves as the perfect display case. Crafted from 2mm thick steel tubing with tough PVC-lined shelves and a black powder-coated finish, the rack stores up to 8x kettlebells and helps keep them organized for competitors.



Order Code	Item Description
ZFT-KBRK-3699	Performance Kettlebell Storage Rack

Description		Performance Kettlebell Storage Rack
Specifications		Made with oval steel tubing, thick plate steel, welded frames, black- or chrome-colored hardware and PVC shelf lining
Product Color		Black powder-coated finish
Storage		Fits Up to 8x competition kettlebells
Dimensions		100cm x 60cm x 78cm - 37kg
Warranty		Limited 5 year warranty on frames and welding, 1 year on plastic parts



PERFORMANCE 3-TIER UNIVERSAL STORAGE RACK

The ZIVA® 3-Tier Universal Storage Rack provides a place for everything and helps you keep everything in its place. This commercial-quality rack neatly organizes and attractively displays all your ZIVA gear, whether it's medicine balls, kettlebells, dumbbells, or even core sandbags. With its thick oval tubing and durable powder-coated finish, it's functional furniture perfectly suited to your gym.



Order Code
ZFT-MFSR-9884

Item Description
Performance 3 Tier Universal Storage Rack

Description		Performance 3 Tier Universal Storage Rack
Specifications		Made with oval steel tubing, thick plate steel, welded frames, black- or chrome-colored hardware and PVC shelf lining
Storage		Fits up to 3x pairs of hexagon dumbbells, 3x kettlebells, and 2x exercise balls
Product Color		Black powder-coated finish
Dimensions		82cm x 64cm x 118cm - 47kg
Warranty		Limited 5 year warranty on frames and welding, 1 year on plastic parts

PERFORMANCE WOODEN PLYO BOX

Built to withstand intense HIIT workouts at the high frequency of a commercial gym, the ZIVA® Wooden Plyometric Jump Box offers a satisfying, reverberating thud with each jump onto its stable, sturdy landing surface. Crafted from commercial-grade, high-durability composite plywood with a bonded exterior and beveled edges, this no-nonsense functional fitness mainstay offers 3 different intensities depending on which way it's turned. Whether at 50, 60, or 70cm, it delivers workouts that build speed, explosivity, and power with a head turning minimalist aesthetic.



Order Code
ZFT-PBWD-7233

Item Description
Performance Wooden Plyo Box

Description		Performance Wooden Plyo Box
Specifications		Made from plywood
Product Color		Natural brown
Dimensions		50cm x 60cm x 75cm
Warranty		Limited 6 month warranty

PERFORMANCE PLYO BOX

How do you get high-intensity high jumps with low risk and low impact? The ZIVA® 3-in-1 Plyometric Jump Box. Our plyo box consists of a commercial-grade, high-durability anti-slip PVC skin that easily goes on and off of a PE foam core that athletes can set any of 3 ways for different intensities. Turn it one way, and it's a tough 20z step platform that works the calves, hamstrings, and glutes. Turn it another, and it's a high-intensity jump workout tool that challenges you to leap 24" high and land gracefully on its soft surface. Give it one more turn, and you have to soar to 30" for workouts that build speed, explosivity, and power.



Order Code
ZFT-TRPY-4014

Item Description
Performance Plyo Box

Description		Performance Plyo Box
Specifications		Made from PE foam inner core, with PVC outer coating
Product Color		Black with grey and white
Warranty		Limited 1 year warranty

PERFORMANCE SLED

For the functionally focused gym frequented by sport-specific training clientele, the ZIVA® Performance Sled is a crucial piece of equipment. Built to be ultra-durable, the sled consists of a steel frame and 4x exterior bars – two on each side so it can be pushed back and forth without having to turn it around – and a central loading bar, all with a wear-, rust-, and corrosion-resistant black powder-coating. The sled itself weighs 26kg and the central bar can fit up to 10x bumper plates for an intense full-body workout that develops users' legs, core, arms, shoulders, and explosivity.



Order Code
ZFT-PWSD-4016

Item Description
Performance Sled

Description		Performance Sled
Specifications		Made with steel frame and bars
Product Color		Black powder-coated finish
Storage		Fits up to 10x bumper plates
Dimensions		86cm x 51cm x 91cm - 26kg
Warranty		Limited 5 year warranty on frames and welding, 1 year on plastic parts

PERFORMANCE BATTLE ROPE

The ZIVA® Performance Battle Rope is the perfect harmony of high intensity interval training and complete upper body and core building exercise. Weighing in at 9kg, our Battle Rope is light enough to facilitate an exhaustive cardio workout for athletes, and heavy enough to build strength in shoulders, arms, back, and core. Woven from nylon with tough rubber handles, the Battle Rope is built rugged and durable enough to survive the rigors of a commercial gym.



Order Code
ZFT-BTRP-0912-BK
ZFT-BTRP-0913-BK
ZFT-BTRP-0914-BK
ZFT-BTRP-0915-BK
ZXP-RGAT-0987

Item Description
ZIVA Battle Rope (5cm * 15m)
ZIVA Battle Rope (3.8cm * 10m)
ZIVA Battle Rope (3.8cm * 15m)
ZIVA Battle Rope (5.0cm * 10m)
Wall Mounted Battle Rope D-Handle Attachment





Description		ZIVA Battle Rope
Specifications		Made from hard-wearing nylon & PP rope and with a nylon cover, rubber handles and a steel ring
Product Color		Black and grey
Warranty		Limited 1 year warranty

PERFORMANCE BODYWEIGHT TRAINER SYSTEM

We have taken this functional fitness mainstay and upgraded its flexibility and versatility. The ZIVA® Performance Body Weight Training System uses a tough forged steel cam buckle that makes adjustments easy; commercial-grade certified steel carabiners with keylock noses for easy attachment and removal; and a reinforced strapping loop with exceptional load-bearing capacity that allows for a huge variety of functional exercises. Our Body Weight Training System can be used like a traditional suspension training system, but utilizes a unique individually anchored handle strap design that also allows for each handle to be anchored separately, allowing for exponentially greater exercise variation and workout design.



Order Code	Item Description
ZFT-APUS-0921-BK	Performance Bodyweight Trainer System
ZFT-WASK-6690	Performance Bodyweight Training Wall Anchor Kit

Description		Performance Bodyweight Trainer System
Specifications		Made with nylon strapping and with chrome & painted hardware
Product Color		 Black and grey
Warranty		Limited 1 year warranty



ACCESSORIES



Order Code	Item Description	Order Code	Item Description
ZFT-FTAH-0556	1 Adjustable Hurdles 5 Pcs Set	ZFT-SBRT-0545	8 Performance Resistance Tube with Safety Sleeve Light
ZFT-FTAL-0512-YL	2 Agility Ladder 15" Spacing	ZFT-SBRT-0546	9 Performance Resistance Tube with Safety Sleeve Medium
ZFT-FTAC-0488	3 Agility Cones & Carry Stand 30 pieces	ZFT-SBRT-0547	10 Performance Resistance Tube with Safety Sleeve Heavy
ZFT-FTAC-0464	4 Agility Cones & Carry Stand 15 pieces	ZFT-SBRT-0548	11 Performance Resistance Tube with Safety Sleeve Extra Heavy
ZFT-FPST-0179	5 Abs Pad	ZFT-DFRL-0274	12 Foam Roller
ZFT-PRLT-0430-BK	6 Parallettes	ZFT-MPSS-1405	13 Multi-purpose straps
ZFT-SKRP-0531	7 Aluminum Speed Jump Rope		

ACCESSORIES



Order Code	Item Description	Order Code	Item Description
PUR-CRAW-0270	14 Abdominal Wheel	ZFT-WDRS-7191	21 Performance Wooden Rings Set
ZFT-SBRT-0545	15 Performance Resistance Tube with Safety Sleeve Light	ZFT-DPBT-0284	22 Dip Belt
ZFT-SBRT-0546	16 Performance Resistance Tube with Safety Sleeve Medium	ZFT-WTLB-0280	23 Weightlifting Belt S
ZFT-SBRT-0547	17 Performance Resistance Tube with Safety Sleeve Heavy	ZFT-WTLB-0281	24 Weightlifting Belt M
ZFT-SBRT-0548	18 Performance Resistance Tube with Safety Sleeve Extra Heavy	ZFT-WTLB-0282	25 Weightlifting Belt L
ZFT-MNBD-0429	19 Loop Resistance Band Set (3 pieces)	BFH-NSRL-0001	26 Neck Support
ZXP-WMPU-0958-CC	20 XP Wall-Mounted Pull-Up Bar (1.2m Station)		

ZIVA

— THE WAY TO LIVE —

www.ziva.com

 facebook.com/ziva.global

 instagram.com/ziva.global

T +420 739 247 424 | E info@ziva-fitness.com

ZIVA Europe s.r.o Headquarters
Opletalova 1525/39, 110 00 Praha 1, CZECH REPUBLIC

EDC – European Distribution Center
Kojetinska 3151/73G, 750 02 Prerov, CZECH REPUBLIC